

SCIENCO
**SOUTHERN BRAZILIAN JOURNAL
OF CHEMISTRY**

ISSN 0104-5431

**AN INTERNATIONAL FORUM FOR THE RAPID PUBLICATION
OF ORIGINAL SCIENTIFIC ARTICLES DEALING WITH CHEMISTRY AND
RELATED INTERDISCIPLINARY AREAS**

VOLUME THREE, NUMBER THREE

DECEMBER 1995

EDITOR

LAVINEL G. IONESCU, Departamento de Química, CCNE, Universidade Luterana do Brasil, Canoas, RS & Instituto de Química, Pontifícia Universidade Católica do Rio Grande do Sul, Porto Alegre, RS BRASIL

EDITORIAL BOARD

- FARUK NOME AGUILERA, Departamento de Química, Universidade Federal de Santa Catarina, Florianópolis, SC, Brasil
- D. BALASUBRAMANIAN, Centre for Cellular and Molecular Biology, Hyderabad, INDIA
- HÉCTOR E. BERTORELLO, Departamento de Química Organica, Facultad de Ciencias Químicas, Universidad Nacional de Córdoba, Córdoba, ARGENTINA
- AÉCIO P. CHAGAS, Instituto de Química, UNICAMP, Campinas, SP, BRASIL
- JUAN JOSÉ COSA, Departamento de Química y Física, Facultad de Ciencias Exactas, Universidad Nacional de Río Cuarto, Río Cuarto, ARGENTINA
- GLENN A. CROSBY, Department of Chemistry, Washington State University, Pullman, WA, USA
- VITTORIO DEGIORGIO, Dipartimento di Elettronica, Sezione di Fisica Applicata, Università di Pavia, Pavia, ITALIA
- JOSÉ C. TEIXEIRA DIAS, Departamento de Química, Universidade de Coimbra, Coimbra, PORTUGAL
- OMAR A. EL SEOUD, Instituto de Química, Universidade de São Paulo, São Paulo, SP, BRASIL
- ERNESTO GIESBRECHT, Instituto de Química, Universidade de São Paulo, São Paulo, SP, BRASIL
- FERNANDO GALEMBECK, Instituto de Química, UNICAMP, Campinas, SP, BRASIL
- NISSIM GARTI, Casali Institute of Applied Science, Hebrew University of Jerusalem, Jerusalem, ISRAEL
- GASPAR GONZALEZ, Centro de Pesquisa, CENPES-PETROBRAS, Ilha do Fundão, Rio de Janeiro, RJ, BRASIL
- YOSHITAKA GUSHIKEM, Instituto de Química, UNICAMP, Campinas, SP, BRASIL
- WILLIAM HASE, Department of Chemistry, Wayne State University, Detroit, MI, USA
- I. B. IVANOV, Laboratory of Thermodynamics and Physico-chemical Hydrodynamics, Faculty of Chemistry, University of Sofia, Sofia, BULGARIA
- IVAN IZQUIERDO, Departamento de Bioquímica, Universidade Federal do Rio Grande do Sul, Porto Alegre, RS, BRASIL
- V.A. KAMINSKY, Karpov Institute of Physical Chemistry, Moscow, RUSSIA
- MICHAEL LAING, Department of Chemistry, University of Natal, Durban, SOUTH AFRICA
- EDUARDO LISSI, Departamento de Química, Universidad de Santiago de Chile, Santiago, CHILE
- WALTER LWOWSKI, Department of Chemistry, New Mexico State University, Las Cruces, N.M., USA
- CRISTINA MANDRAVEL, Catedra de Chimie Fizica, Facultatea de Chimie, Universitatea din Bucuresti, Bucuresti, Romania
- C. MANOHAR, Bhabha Atomic Research Centre, Chemistry Division, Bombay, INDIA
- AYRTON FIGUEIREDO MARTINS, Departamento de Química, Universidade Federal de Santa Maria, Santa Maria, RS, BRASIL
- FRED MENGER, Department of Chemistry, Emory University, Atlanta, GA, USA
- MICHAEL J. MINCH, Department of Chemistry, University of the Pacific, Stockton, CA, USA
- K. L. MITTAL, IBM Corporate Technical Institutes, Thornwood, N.Y., USA
- ARNO MÜLLER, Escola de Engenharia, Universidade Federal do Rio Grande do Sul, Porto Alegre, RS, BRASIL
- JOSE MIGUEL PARERA, Instituto de Investigaciones en Catalisis y Petroquímica, Universidad Nacional del Litoral, Santa Fe, ARGENTINA
- LARRY ROMSTED, Department of Chemistry, Rutgers University, Piscataway N.J., USA
- GILBERTO FERNANDES DE SÁ, Departamento de Química Fundamental, Universidade Federal de Pernambuco, Recife, PE, BRASIL
- DIMITRIOS SAMIOS, Instituto de Química, Universidade Federal do Rio Grande do Sul, Porto Alegre, RS, BRASIL
- DIÓGENES DOS SANTOS, Department of Molecular Biology, Oxford University, Oxford, ENGLAND
- JOSEPH A. SCHUFLE, Department of Chemistry, New Mexico Highlands University, Las Vegas, N.M., USA
- BEN K. SELINGER, Department of Chemistry, Australian National University, Canberra, AUSTRALIA
- KOZO SHINODA, Department of Applied Chemistry, Faculty of Engineering, Yokohama National University, Yokohama, JAPAN
- CRISTOFOR I. SIMIONESCU, Academia Română, Filiala Iasi, Iasi, ROMANIA
- BRUNO SZPOGANICZ, Departamento de Química, Universidade Federal de Santa Catarina, Florianópolis, SC, Brasil
- UMBERTO TONELLATO, Dipartimento di Chimica Organica, Università degli Studi di Padova, Padova, ITALIA
- DIETER VOLLHARDT, Max Planck Institut für Kolloid und Grenzflächenforschung, Berlin, GERMANY
- RAOUL ZANA, Institut Charles Sadron, CRM-EAHP, Strassbourg, FRANCE

SOUTHERN BRAZILIAN JOURNAL OF CHEMISTRY

ISSN 0104-5431

VOLUME THREE, NUMBER THREE DECEMBER 1995

CONTENTS / CONTEÚDO

LUIS FREDERICO LELOIR - SOUTH AMERICA'S ONLY NOBEL LAUREATE IN CHEMISTRY Lavinel G. Ionescu and Clovis Antônio Perazzolo	1
DETERMINATION OF ACETATE IN FOODS BY ION CHROMATO- GRAPHY-FLOW INJECTION E.Esteve-Juan, R. Puchades and A. Maquieira	9
CHARACTERIZATION OF GEOCHEMICAL PARAMETERS OF AN ORGANIC SOIL FROM TERRA DE AREIA, NORTHERN COASTAL PLAIN, RIO GRANDE DO SUL, BRAZIL Adriana Olmos da Rocha and Paulo César Pereira das Neves	23
MATHEMATICAL CORRELATION BETWEEN MASS TRANSFER COEF- FICIENTS AND PARAMETERS INFLUENCING THE PENICILLIN G EXTRACTION PROCESS Dan Cascaval, Corneliu Oniscu and Adina Dumitrascu ...	37
KINETICS OF OXIDATION WITH HYDROGEN PEROXIDE AND IRON(II) COMPLEX WITH A MACROCYCLIC BINUCLEATING LIGAND Lourdes T.Kist, Bruno Szpoganicz, Manuel G. Basallote, Maria J. F. Trujillo and Maria A. Mániz	55
INTERNAL PRESSURE OF LIQUIDS AND THE RATE OF A MICELLAR CATALYZED REACTION Lavinel G. Ionescu and Elizabeth Fátima de Souza	63
SYNTHESIS OF SOME PHENOXATHIIN DERIVATIVES WITH ANTI- MICROBIAL ACTIVITY O. Maior, D. Gavriliu and S. Stoia	79
CARBON-13 NMR OF ALIPHATIC TERTIARY AMINES Paulo Irajara Borba Carneiro and Roberto Rittner	89
Author Index	93

SOUTHERN BRAZILIAN JOURNAL OF CHEMISTRY

SOUTH. BRAZ. J. CHEM., Vol.3 N° 3, 1995

1

LUIS FREDERICO LELOIR - SOUTH AMERICA'S ONLY NOBEL PRIZE LAUREATE IN CHEMISTRY

Lavinel G. Ionescu*

Instituto de Química

Pontifícia Universidade Católica do Rio Grande do Sul

Porto Alegre, RS BRASIL 90619-900 &

Departamento de Química

Centro de Ciências Naturais e Exatas

Universidade Luterana do Brasil

Canoas, RS BRASIL 92420-280

&

Clóvis Antônio Perazzolo§

Antarctic Training Program

McMurdo Station, ANTARCTICA

ABSTRACT

Luis Frederico Leloir, South America's only Nobel Laureate in Chemistry was born in Paris, France in 1906 and died in Buenos Aires, Argentina in 1987. He graduated as a physician from the University of Buenos Aires and was a student of Bernardo Houssay. With his own resources and help from his friends he founded in 1947 the Instituto de Investigaciones Bioquímicas (Fundación Campomar). He became famous for his research dealing with sugar nucleotides, bioynthesis of carbohydrates and oxidation of fatty acids. He was awarded the Nobel Prize in Chemistry in 1970.

RESUMO

Luis Frederico Leloir, o único Laureado do Prêmio Nobel em Química da América do Sul nasceu em Paris, França em 1906 e faleceu em Buenos Aires Argentina em 1987. Formou-se como médico na Universidade de Buenos Aires e foi aluno de Bernardo Houssay. Com recursos próprios e ajuda de seus amigos fundou em 1947 o Instituto de Investigaciones Bioquímicas (Fundación Campomar). Ficou famoso por seus trabalhos com nucleotídeos de açúcares, biossíntese de carboidratos e oxidação de ácidos graxos. Em 1970 Leloir foi laureado com o Prêmio Nobel em Química.

Luis Frederico Leloir was born in Paris, France on September 6, 1906. His parents, members of a traditional family from the Provence were living in Europe at the time.

* To whom correspondence should be addressed at PUCRS.

§ Professor Emeritus, Departamento de Química Orgânica, UFRGS.

When Leloir was two years old, his family moved definitely to Argentina and settled in Buenos Aires. They became very prosperous and were readily accepted as members of the high society of the Argentine Capital.

He grew up and did all of his formal studies in Buenos Aires. Leloir graduated as a physician from the University of Buenos Aires in 1932 and was awarded the Doctor of Medicine Degree two years later, in 1934. His doctoral thesis entitled "*Suprarenales e Hidratos de Carbono*" was done under the supervision of Bernardo Houssay, who in 1947 was awarded the Nobel Prize in Medicine and Physiology.

In 1935 Leloir went to England where he worked with Sir Frederic Gowland Hopkins (Nobel Prize in Medicine and Physiology of 1929) in the Biochemical Laboratory in Cambridge. After his return to Argentina in 1937, Leloir went back to work in the Instituto de Fisiologia directed by Houssay. In collaboration with Juan M. Muñoz he studied the oxidation of fatty acid. They obtained the first system of living cells that were able to oxidize fatty acids in vitro.

In subsequent studies in the same institute, in collaboration with Carlos Taquini, Juan C. Fasciolo and Eduardo Brown Menéndez dealing with renal hypertension, he discovered angiotensin, a protein responsible for the increase in arterial blood pressure.

In 1943 Luis Frederico Leloir went to the United States of America where he remained for a period of about three years and worked with Green and Cori. Upon his return to Argentina in 1947, with his own resources and help from friends and relatives and the industrialist Jaime Campomar, Leloir founded the Instituto de Investigaciones Bioquímicas. During its inauguration, on November 3, 1947 Leloir said the following prophetic words. "*El Instituto de Investigaciones Bioquímicas comienza sus actividades en un lugar pequeño y provisorio, pero esperamos que sean grandes su labor y su futuro*". ("The Institute of Biochemical Research begins its activities in a small and temporary location, but we hope that its deeds and its future shall be great").

The founding members of the Institute together with Leloir were Ranwell Caputto, Raul Trucco, Carlos E. Cardini and Alejandro C. Paladini. A picture of the original building on Julian Alvarez Street, Buenos Aires, where the Institute was housed from 1947 to 1958 is shown in Figure 2.



FIGURE 1. LUIS FREDERICO LELOIR AND HIS FAMOUS CHAIR.



FIGURE 2. BUILDING ON JUAN ALVAREZ STREET Nº 1917 IN THE PALERMO DISTRICT OF BUENOS AIRES WHERE THE INSTITUTO DE INVESTIGACIONES BIOQUIMICAS FUNCTIONED FROM ITS FOUNDING IN 1947 UNTIL 1958.

The first research work done in the new laboratory was the synthesis of lactose. This work was very complicated and involved a detailed study of the metabolism of glucose and galactose. It eventually led to the synthesis and discovery of the first sugar nucleotide, uridine diphosphate glucose (UDPG). The conversion of galactose 1-phosphate to glucose 1-phosphate is generally known in biochemistry as the "Leloir Pathway" and is illustrated in Figure 3. This and other interconversions of hexoses take place at the sugar nucleotide level and was unknown at the time. Leloir's studies led to the discovery of both UDP glucose and UDP galactose and to a Nobel Prize in Chemistry to be awarded almost a quarter of a century later in 1970. Subsequently, his group synthesized more than a dozen sugar nucleotides. Eventually Leloir, Carlos E. Cardini and the Peruvian scientist Jorge Chiriboga succeeded and discovered the enzymatic synthesis of sucrose.

In 1958, the Instituto de Investigaciones Bioquímicas moved to new facilities in a building located on Obligado Street Nº 2490 in Buenos Aires (Figure 4). The first discovery at the new location was the enzyme starch synthetase.

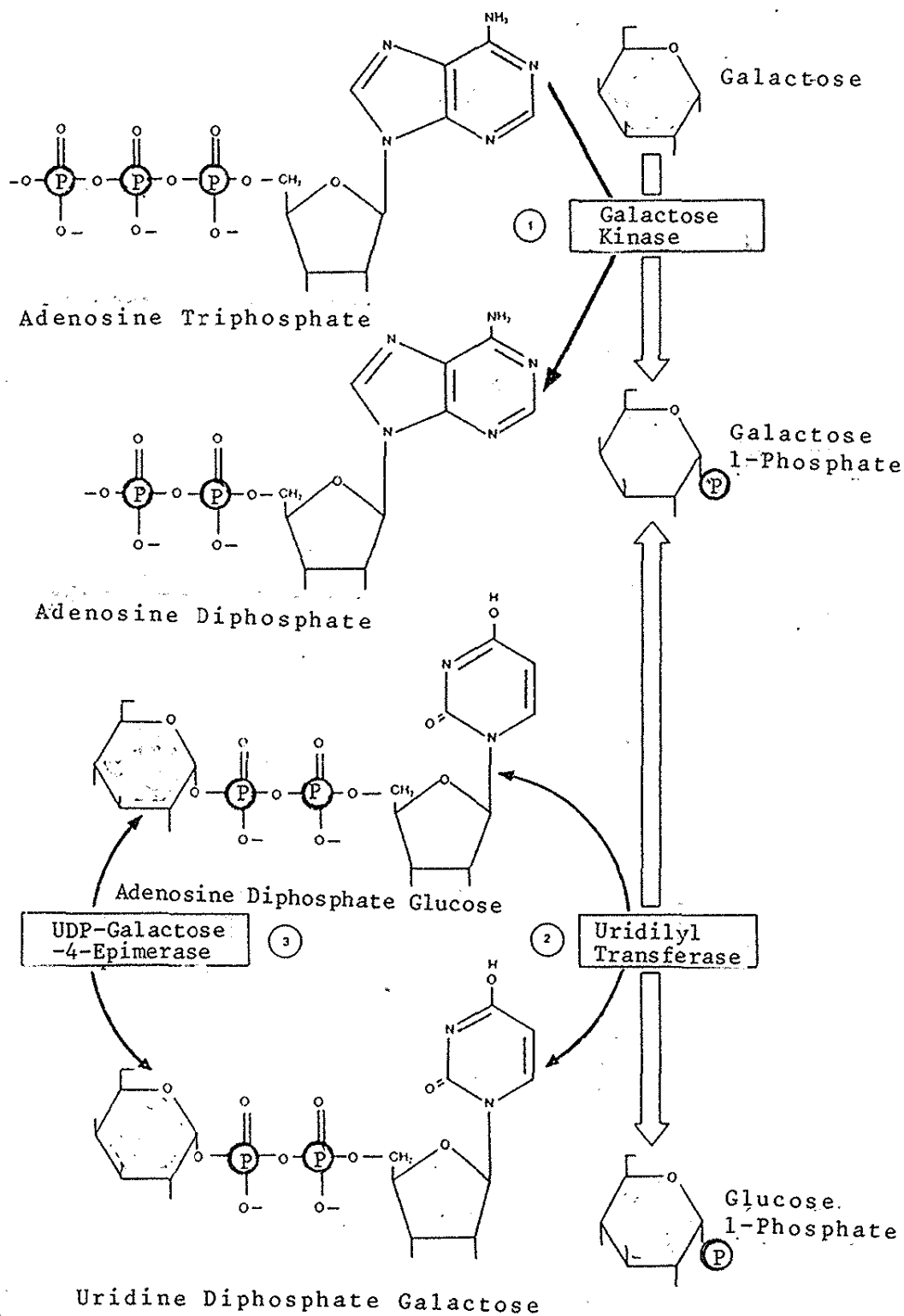

FIGURE 3. THE LELOIR PATHWAY.

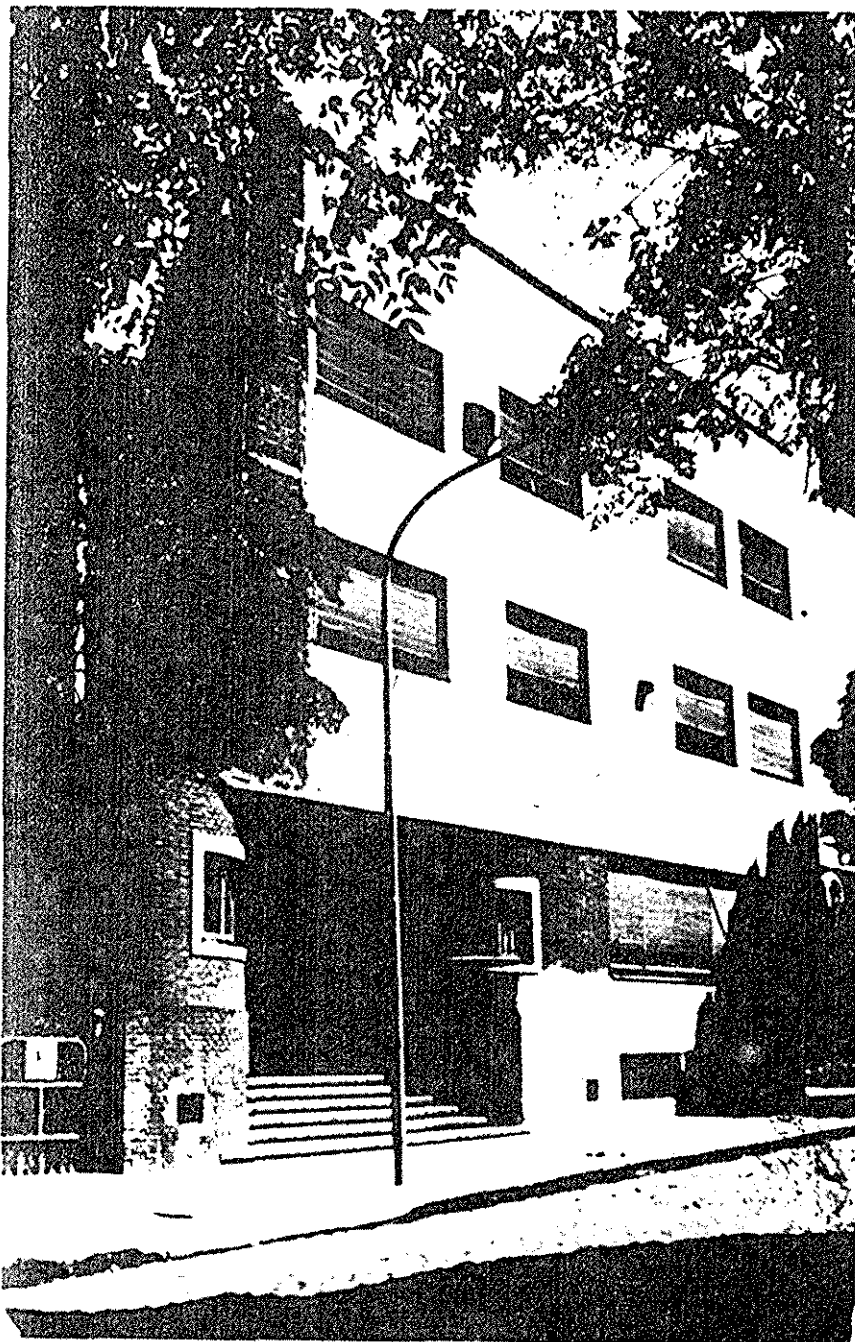

FIGURE 4. NEW BUILDING OF FUNDACIÓN CAMPOMAR LOCATED ON OBLIGADO STREET N° 2490, BUENOS AIRES.

Other important contributions made by Leloir and his collaborators dealt with the synthesis of glycogen and the biochemistry of lipids.



FIGURE 5. LUIS FREDERICO LOEIR AND SOME OF HIS COLLABORATORS AT FUNDACIÓN CAMPOMAR.
(Prof. C. A. Perazzolo is the first one on the right.)

On October 27, 1970 Luis Frederico Leloir was awarded the Nobel Prize in Chemistry, the first received by a Latin American chemist. Many years later, in 1995, a second Latin American, the Mexican chemist Mario Molina was awarded the Nobel Prize in Chemistry together with Paul Crutzen and F. Sherwood Rowland for their work dealing with the ozone layer.

Leloir was for many years the most respected scientist in Argentina and was a member of Argentina's elite. By marriage he became related to one of the richest and most influential families of Buenos Aires. In spite of all this, he led a modest life and worked on his research projects up to the very end. He used to drive a modest Fiat Seicento automobile and went to work every day to the Instituto de Investigaciones Bioquímicas taking his lunch box along. He dispensed fancy restaurants and preferred to eat lunch with his collaborators. He also liked to drink a glass of wine with all of his meals. One of his favorite things was his famous straw chair. Unlike many scientists in Latin America that are part of the select ruling class and are more interested in maintaining things as they are, Luis Frederico Leloir never forgot the social, ethical and moral responsibilities of a true scientist.

He died in Buenos Aires, Argentina at the age of 81, on December 2, 1987. His good example is alive among the chemists and biochemists of Argentina and his disciples in other countries and continents.

REFERENCES

1. A. L. Lehninger, *Biochemistry - The Molecular Basis of Cell Structure and Function*, Worth Publishers, New York, 1975.
2. L. Stryer, *Biochemistry*, W.H. Freeman and Co., San Francisco, California, USA, 1975.
3. D. E. Metzler, *Biochemistry - The Chemical Reactions of the Living Cell*, Academic Press, New York, 1977.
4. L. F. Leloir, *Science*, 172, 1299 (1971).
5. L. F. Leloir and C. E. Cardini, *Nucleotide Diphosphate Sugars: Perspectives in Biology*, Elsevier, Amsterdam, 1963.
6. L. F. Leloir, *Biochem. J.*, 91, 1 (1964).
7. S. Passeron and M. Dankert, *Bagó Informa*, 3(11), 3 (1972).
8. L. G. Ionescu and C. A. Perazzolo, *Químico Pampeano*, 8(28), 12 (1994).
9. C. A. Perazzolo, Personal Reminiscences.
10. L. G. Ionescu, *Supl. Ciência e Cultura*, 40(7), 594 (1988).
11. L. G. Ionescu, *História e Filosofia da Ciência e o Ensino da Química*, Monografia, Universidade Federal de Santa Maria, Santa Maria, RS, Brasil, 1988.

**DETERMINATION OF ACETATE IN FOODS BY ION CHROMATOGRAPHY-
FLOW INJECTION**

*E. Esteve-Juan, R. Puchades and A. Maquieira**

Department of Chemistry, Polytechnic University of Valencia,
E-46071 Valencia, Spain.

ABSTRACT. A method for acetate determination using IC separation and FI post-column spectrophotometric detection based on the $\text{La}(\text{OH})_3\text{-I}_2$ reaction has been developed. The chromatographic conditions (eluants, flow-rates, sensitivity and so on) and FI variables (length of coils, injection volume, pH,...) were optimised. Linearity was observed over the concentration range 0 to 1 g l^{-1} with HAc as standard ($r = 0.9916$) and a detection limit of 0.1 g AcH/l . The IC-FI method afforded a low relative standard deviation (3.6%) and was free from interferences. The IC-FI procedure was applied to the determination of acetate in mustard sauce and the results obtained agree with those provided by the reference method. Additionally, the developed method permits the simultaneous chromatographic analysis of other anions such as chloride, nitrate, phosphate, sulphate and so on.

RESUMO. Desenvolveu-se um método para determinação de Acetato utilizando separação por cromatografia iônica e detecção espectrofotométrica com injeção de fluxo baseada na reação $\text{La}(\text{OH})_3\text{-I}_2$. Otimizou-se as condições cromatográficas (eluentes, relação de fluxo, sensibilidade etc) e as variáveis de FI-injeção de fluxo em (longitudes dos tubos, injeção de volume, pH,...). Observou-se uma linealidade sobre a concentração em uma faixa de 0 a 1 g l^{-1} com solução padrão HAc ($r = 0,9916$) e um limite de detecção de $0,1 \text{ g AcH/l}$. O método IC-FI aportou uma desvio padrão relativamente baixo (3,6) e livre de interferências. O procedimento IC-FI foi aplicado na determinação de Acetato em mostardas e os resultados obtidos concordam com o método de referência. Além disso o desenvolvimento do método permite a análise cromatográfica simultânea de outros aniões tais como cloro, nitrato, fosfato, sulfato, etc.

KEYWORDS: acetate, flow-injection, ion chromatography, UV/V detection, foods.

INTRODUCTION

Ion chromatography (IC) is a sensitive, and versatile analytical technique, useful for the determination of ions. From its birth¹ it has been applied to solve a great number of problems^{2,3} in several fields such as clinical, food, industrial and environmental analysis with satisfactory results.

The lack of selectivity and/or sensitivity of most of the detectors is one of the handicaps of this technique. The conductivity detector shows a good sensitivity, though its selectivity is nearly null.

The hyphenation of analytical techniques has proved to be very useful to solve this kind of problems⁴. Generally, chromatographic techniques with post-column derivation^{5,6} are used, because it combines a methodology with a great separation ability with high performance detectors.

The coupling of both the separation and identification stages and the automation of the analytical process can be carried out by the FI technique^{7,8}. Despite of its potential, the advantages of IC-FIA combination applied to the development of analytical methodologies have not been sufficiently exploited⁹.

The determination of acetate is a major difficulty in the analysis of a great deal of industrial, food, fermented and natural products, as it is—in many cases—a basic anion for manufacturing or conservation. For this reason, a lot of methods have been developed making use of techniques such as GC¹⁰ or HPLC^{11,12}.

The acetate appraising in complex samples requires the use of separation techniques, especially if ionic components such as chlorides, sulphates, nitrates or phosphates are to be simultaneously analysed.

The aim of our work is to test the suitability of IC-UV/V coupled with FI for the automatic analysis of acetate in mustard sauce. This could mean a considerable increase in the versatility and selectivity of the technique, with hardly any sample pre-treatment.

EXPERIMENTAL PROCEDURE

Materials and Equipment

The determinations were carried out in a Dionex 2000 i/sp ion chromatograph equipped with the following columns: guard HPIC-AG4A, analytical HPIC-AS4A and suppressor micromembrane AMMS-1, a conductivity detector and Dionex 4290 integrator. The flow injection system consists of a Gilson Minipuls-3 peristaltic pump, a Rheodyne 5701 4-way pneumatic injection valve, a thermostatic water bath and a Pye-Unicam 8625 UV/V spectrophotometer, model 8625 equipped with a Hellma QS 1000 flow-cell (inner volume 18 μ L).

Sample management and data acquisition were carried out by a personal computer. Communication software was programmed in C language¹³. The interface used was a PCL-712 PC-LabCard.

- FI Reagents

A 0.1 M $\text{La}(\text{NO}_3)_3 \cdot 6\text{H}_2\text{O}$ solution was used. A 0.01 M aqueous solution I_3^- was prepared by dissolving 1.27 g of I_2 and 4 g of KI made up to a final volume of 1 l with distilled water; this solution was standardised with As_2O_3 and starch as indicator. The $\text{NH}_3/\text{Na}_2\text{H}_2\text{Y}/\text{Ca}^{2+}$ (Y=EDTA) aqueous solution was prepared by dissolving 1.54 mL of

NH_4OH conc., 0.372 g of $\text{Na}_2\text{EDTA}\cdot 2\text{H}_2\text{O}$ (ethylenediaminetetraacetic acid disodium salt dihydrated) and 1.64 g of $\text{Ca}(\text{NO}_3)_2$ in 100 mL of distilled water. This solution is 0.23 M NH_3 , 0.01 M $\text{Na}_2\text{H}_2\text{Y}$ and 0.1 M $\text{Ca}(\text{NO}_3)_2$. 1 M aqueous solutions of Mg^{2+} , Ca^{2+} , Sr^{2+} , and Ba^{2+} were prepared from their nitrate salts.

- IC Reagents

Regenerant: H_2SO_4 0.025M. Eluants: sodium tetraborate 0.005M prepared by dissolving 7.628 g of $\text{Na}_2\text{B}_4\text{O}_7\cdot 10\text{H}_2\text{O}$ in 4 l of distilled-deionized water. Ten different $\text{CO}_3^{2-}/\text{HCO}_3^-$ rates were prepared in water (Table IV).

- Other reagents

Pure ethylene glycol ($d = 1.11\text{ g l}^{-1}$); 10% aqueous solution of hydroxylamine-hydrochloride; 0.074 M FeCl_3 solution in a 0.37 M H_2SO_4 medium; 1% solution of N-N'-dicyclohexyl-carbodiimide in methanol; 1:1 solution of Cl-hydroxylamine 10% and 2.5M NaOH in methanol; 1 M Fe^{3+} solution obtained from iron in concentrated perchloric acid (70%), and 0.1 M AgNO_3 were also used.

- Standards

Artificial matrix: Aqueous solution containing 100 mL of 96% ethanol, 0.5 mL of concentrated sulphuric acid, 6 g of sodium chloride, 7 g of citric acid, 2 g of glycerol, 3.8 g of tartaric acid, 3 g of glucose and 0.88 mL of concentrated phosphoric acid per liter.

Acetate standards: prepared by adding acetic acid (density 1.05 g mL^{-1}) to different solvents, namely: distilled water, distilled deionised water, and artificial matrix (diluted 1:5 with distilled deionised water) at different concentrations (0.1, 0.3, 0.5, 0.7 and 1.0 g l^{-1}). All reagents used were of analytical grade.

Sample pretreatment

To obtain the mustard sauce extract the procedure proposed by Canalé-Gutiérrez et al.¹⁴ was followed with some modifications. 5 g of mustard sauce are added to 25 mL of ethanol. The mixture is then stirred and centrifuged. Afterwards, the remaining solution is diluted 1:5 with distilled deionised water.

RESULTS AND DISCUSSION

FI method

In order to develop the FI method, different reactions¹⁵ have been tested in batch for the determination of acetate:

a) Esterification of acids with ethylenglycol followed by the conversion into the corresponding hydroximate and development of a red-violet color with ferric ion. The batch method gave rise to doubtful results with appearance of precipitates and low reproducibility.

b) Esterification with methanol in the presence of N-N'-dicyclohexylcarbodiimide at pH 3 followed by the same steps mentioned above. Batch tests showed the appearance of precipitates which were redissolved by adding Cl-hydroxylamine and sodium hydroxide. However, the complex formed was unstable and the absorbance heavily decreased yielding unacceptable results.

c) Some substances such as lanthanum acetate give a blue color with iodine¹⁶ when they occur in a colloidal state. Consequently, the addition of lanthanum nitrate in hot ammoniacal medium was assayed, a blue adsorption compound being then formed with triiodide. This reaction¹⁷ is extremely sensitive for acetate: 50 $\mu\text{g Ac}^-$ and a concentration limit of 1 in 2000. Sulphate and phosphate interfere, but this can be avoided by precipitating them with barium nitrate. On the other hand, Cl^- hinders the formation of the colloidal acetate product; this is not cited in the handled literature.

From the batch tests performed, the lanthanum/acetate reaction was selected. The UV/V spectrum of the reaction complex showed a maximum absorption at 640 nm, which was adopted as the monitoring wavelength. A FI manifold was then designed in order to automatise the procedure (Figure 1).

Optimisation of the FI variables

In all cases optimisation of the variables was carried out according to the univariate method¹⁸. The influence of La^{3+} , I_3^- and NH_3 was studied. The precipitation of $\text{La}(\text{OH})_3$ in an alkaline medium may be avoided by adding $\text{Na}_2\text{H}_2\text{Y}$. The great stability of the $\text{La}^{3+}/\text{EDTA}$ complex hinders the formation of precipitates, but dramatically decreases the analytical signal. The addition of a cation which also forms a complex with EDTA in alkaline medium turned out to be a satisfactory solution to control the concentration of free lanthanum, thus increasing the signal.

Therefore Mg^{2+} , Ca^{2+} , Ba^{2+} and Sr^{2+} were assayed as stabilising cations of the analytical reaction. For this purpose, 1M stock solutions of the corresponding nitrates were used; other salts such as sulphates, phosphates or chlorides interfere in the further reaction. The working concentrations of the assayed cations were chosen according to the solubility constants of their hydroxides, stability of their complexes and pH of work¹⁹. In all instances, a 0.12 M concentration was adopted except for Mg^{2+} , due to the insolubility of its hydroxide. The best results were obtained with Ca^{2+} (Table I).

In order to check that the signal obtained was not a consequence of the formation of a calcium/acetate complex²⁰, an assay without lanthanum was carried out, using aqueous standards of up to 1 g l⁻¹ of HAc. Under the experimental conditions no formation of this complex was observed.

Table I
Behaviour of different cations with respect to the formation of the Lanthanum-EDTA complex*

HAc (g l ⁻¹)	Mg^{2+} 0.01 M	Ca^{2+} 0.12 M	Sr^{2+} 0.12 M	Ba^{2+} 0.12 M
0	0.065	0.943	0.898	0.881
0.5	0.050	0.881	0.838	0.824
1.0	0.040	0.785	0.768	0.765

* Results in absorbances

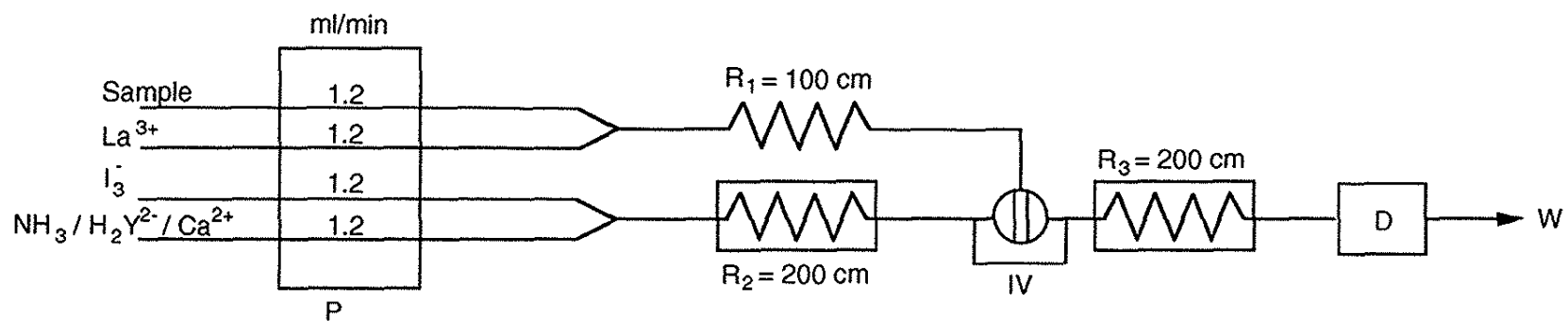

Figure 1. FI manifold for the spectrophotometric determination of acetate. P- Pump, R₁, R₂, R₃- length of the reaction coils (R₂ and R₃ thermostated at 30 °C); IV- Injection valve; D- Detector; W- waste.

Then the influence of the temperature (over the range 15–50°C) was studied. At higher temperatures, the reaction takes place faster, but the signal remains constant. Additionally, bubbles from the release of ammonia appear. Therefore, a very moderate temperature (30°C) turns out to be enough for a sufficiently rapid development of the reaction, which is not possible with temperatures under this value. On the other hand, the alternative of increasing the residence time is not satisfactory, since a precipitate appears as a consequence of prolonging the contact time between the carrier and the sample. For this reason, a temperature of 30 °C was selected in this work.

The pH influence was also studied in the range between 5.5 and 12.5. The optimum pH value –achieved by adding NH_3 – turned out to be 11. An excess of the reagent produces a precipitate, whereas with pH values below 5.5 there is scarcely any reaction. Table II shows the concentration ranges studied for each of reagent (La^{3+} , I_3^- , NH_3 , H_2Y^{2-} and Ca^{2+}), as well as their optimal values.

The studied FI variables together with the results obtained are summarised in Table II. Injection volumes higher than 200 μL give rise to undesirable double peaks,

Table II
Results of the optimisation of FI variables

	Range	Optimum
La^{3+} (M)	0.005–0.1	0.01
I_3^- (M)	0.0005–0.05	0.001
NH_3 (M)	0.005–2	0.23
H_2Y^{2-} (M)	0.006–0.02	0.01
Ca^{2+} (M)	0.04–0.14	0.1
pH	5.5–12.5	11
T (°C)	15–50	30
Injected Vol. (μL)	14–260	43
Flow-rate (mL min^{-1})	0.6–2	1.2
R_1 (cm)	50–200	100
R_2 (cm)	50–300	200
R_3 (cm)	50–300	200

E. Esteve-Juan, R. Puchades & A. Maquieira

whereas values under 20 μL do not yield detectable signals. A volume of 43 μL was used in this work.

The most recommendable flow-rate was 1.2 mL min^{-1} , which produces a sufficient sensitivity as well as a good sampling frequency (80 h^{-1}).

Coil lengths also play a role in the performance of the method. R_1 values over 100 cm result in the appearance of precipitates and double peaks. As for R_2 and R_3 , length values of 200 cm are recommended so that the reagent becomes warm and homogeneous with the carrier without precipitating.

Features of the FI method

With the optimum values of the variables, a calibration graph was run with HAC standards (0.1–1 g l^{-1}). The equation obtained was $\text{Abs} = 381.7 - 159.8(\text{Ac}^-)$ ($r = 0.9996$) and the precision of the method, evaluated on 11 samples of 0.5 g l^{-1} injected in triplicate, was 0.96% RSD.

The validity of the method was studied by comparing it with the distillation reference method²¹. Water and artificial matrix spiked with acetic acid standard are used in both cases. The results obtained (Table III) show that the automatic method is an excellent alternative to the manual procedure.

The influence of the chromatographic eluants ($\text{HCO}_3^-/\text{CO}_3^{2-}$ 1.7 mM/1.8 mM and sodium tetraborate 0.005 M) was evaluated by adding different HAC concentrations (0, 0.5 and 1 g l^{-1}). No interferent effects were observed.

Table III
Comparison between the results obtained in both the reference and the FI methods* for Ac^- determination

HAC added	Water		Artificial Matrix	
	Reference	FI	Reference	FI
0	0.01	0.02	0.02	0.02
0.1	0.12	0.09	0.10	0.09
0.3	0.26	0.30	0.31	0.29
0.5	0.48	0.49	0.49	0.50
0.7	0.69	0.70	0.72	0.72
1.0	0.99	1.00	1.01	0.99

* Concentrations in g l^{-1}

Optimisation of the IC system

Once the FI method was set up, the IC system was then optimised. The working medium was an artificial matrix at concentrations of acetic acid over the range 0.1–1 g l⁻¹. This matrix contains glucose, ethanol, citric acid, glycerol, sodium chloride, tartaric acid, phosphoric acid and sulphuric acid, with the purpose of applying the methodology to real samples. Chloride, though an interfering anion in the spectrophotometric determination, is added since it is common in any type of sample.

Firstly the following working conditions were adopted. Eluant: sodium carbonate 1.8 mM / sodium bicarbonate 1.7 mM, flow-rate 1 mL min⁻¹. Regenerant: sulphuric acid 0.025 M. Flow-rate: 6 mL min⁻¹. Pressure: 44 bar. Sensitivity: 30 µS. Injected sample volume: 50 µL. Under these conditions, the resolution of the chromatogram obtained was not satisfactory and ought to be optimised.

Study of IC variables

Several dilutions of the artificial matrix with distilled deionised water were assayed (1:2, 1:5, 1:10 and 1:50). The best chromatographic results of resolution and reproducibility were obtained with a 1:5 dilution and a pressure of 44 bar.

In order to optimize the sensitivity of the detector, several chromatograms were carried out by injecting the artificial matrix (diluted 1:5) containing 0.5 g l⁻¹ of HAc at sensitivities ranging from 10 µS to 1KS. The optimum value turned out to be 300 µS and was used for subsequent assays.

The optimisation of the eluant concentration was carried out using Na₂CO₃/NaHCO₃ and varying the rate carbonate/bicarbonate. For this purpose, 1 g l⁻¹ of HAc was added to the artificial matrix diluted 1:5 with distilled deionised water. The results obtained are shown in Table IV. It can be noticed that, for a constant concentration of carbonate and an increasing concentration of bicarbonate (eluant 1 to 6), the chromatogram scarcely changes; there is only a slight increase in the area as well as in the retention time of the monovalent anions. On the other hand, if the concentration of bicarbonate decreases, the retention time of the first peaks increases (unlike their width) and so does the area. Additionally, the retention time of sulphates, phosphates and so on decreases and their resolution improves.

If the concentration of bicarbonate remains constant while that of carbonate decreases (eluant 7 to 10), retention times increase and peaks become wider. However, peaks which appear close to acetate can be integrated, at the cost of increasing the retention times of divalent ions up to non-recommendable 20 minutes. The chromatogram can be shortened if the concentration of carbonate is increased up to 2.4 mM (while keeping constant the concentration of bicarbonate), but Ac⁻ and Cl⁻ anions clearly overlap and cannot be separated.

The identification of the peak corresponding to the acetate ion was carried out in eluant number 9, by diluting the artificial matrix (1:5) with water and later adding 10 g l⁻¹ of acetic acid (amount in excess with the purpose of heavily increasing the chromatographic peak of acetate). Its signal corresponds to a retention time –under the working conditions– of 1.94 min. Figure 2 shows a typical chromatogram obtained with the optimized system.

Table IV
Study of the resolution of the chromatograms according to the eluant^a

Eluant No.	[CO ₃ ²⁻]/[HCO ₃ ⁻] (mM)	Monovalent anions ^b		Divalent anions ^c	
		Resolution	RT (min)	Resolution	RT (min)
1	1.8/1.7	No	3,09	Yes	— 7,19 8,44
2	1.8/1.6	No	3,13	Yes	6,34 7,33 9,45
3	1.8/1.8	No	3,13	Yes	6,14
4	1.8/1.4	No	3,27	Yes	— 7,03 8,98
5	1.8/1.0	Yes	0,86 3,34	Yes	5,99 6,90 8,93
6	1.8/0.7	No	3,44	Yes	5,90 6,97 8,97
7	1.4/1.7	No	3,29	Yes	7,37 8,13 10,44
8	1.0/1.7	Yes	1,95 3,35	Yes	9,41 10,81 11,33 12,39
9	0.6/1.7	Yes	1,94 3,65	Yes	13,37 15,32 16,52 18,36
10	2.4/1.7	No	2,88	Yes	5,179 6,06 6,94

a) Sample: artificial matrix; b) Ac⁻ and Cl⁻; c) P: Phosphate, S: Sulphate, T: Tartrate and C: Citrate.

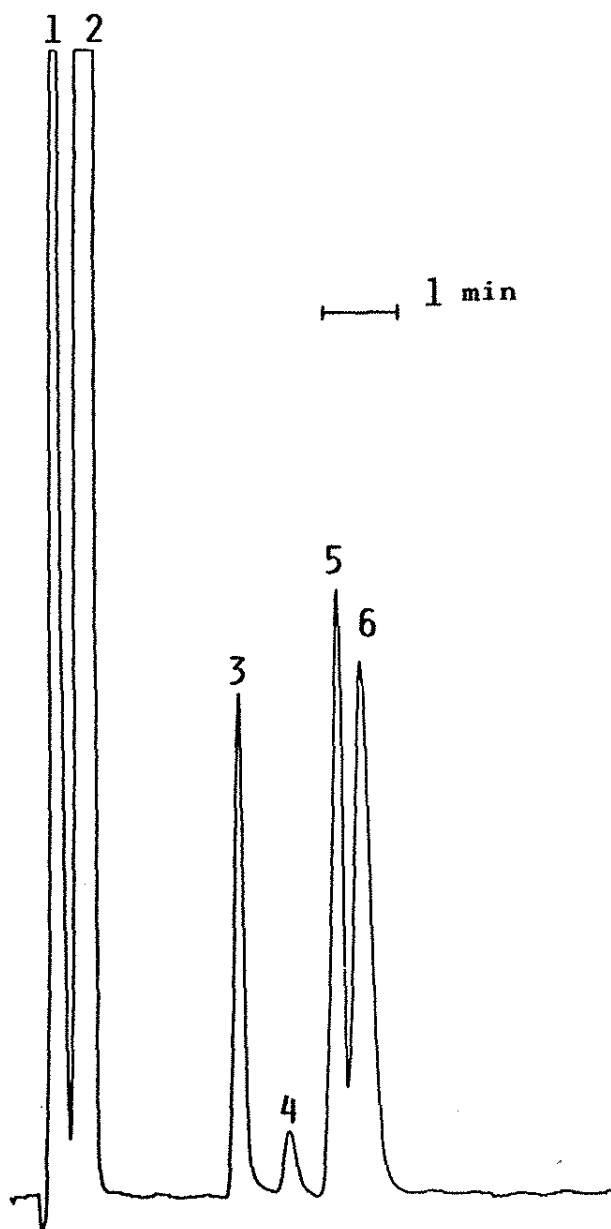

Figure 2. Chromatogram of artificial matrix, diluted 1:5. Eluant number 9, flow rate 0.8 mL min^{-1} . Regenerant H_2SO_4 0.025 M , flow rate 6 mL min^{-1} . Conductivity detector at $300 \mu\text{S}$. 1. Ac^- (RT 2.66, Area 83485605); 2. Cl^- (4.39; 149909639); 3. Phosphate (13.05; 27721055); 4. Sulphate (16.10; 4652336); 5. Tartrate (18.69; 40284386); 6. Citrate (20.04; 55960331).

Features of the IC method

Under the optimum conditions, a calibration graph was run with HAC standards in distilled deionised water at concentrations between 0.1 and 1.0 g l⁻¹. The equation obtained was: Area = 1.25 + 2.64 (HAc) (r= 0.9970). These results show that the methodology is applicable to the determination of acetate in the working medium.

The reproducibility, evaluated on eleven samples of 0.5 g l⁻¹ of HAC in the same medium (artificial matrix diluted 1:5) was 2.03 % RSD, which is acceptable.

IC-FI coupling

The configuration proposed is shown in Figure 3. The hyphenated system is designed in such a way that the chromatograph acts as a separating agent of the acetate from the other compounds of the sample, whereas the FI system acts like a selective spectrophotometric detector for acetate. When both systems are coupled, it is very important to isolate the sample plug containing this anion from the eluate. The location of the injection valve in the FI system plays a key role. Its optimum place is right after the conductivity cell of the chromatographic detector. The automatic injection valve manages to capture the volume containing the Ac⁻ anion by means of the computer. At a constant flow-rate, the computer makes the valve load at a certain time, corresponding to the retention time of Ac⁻ and it remains open for an established period.

The flow-rate of the FI system should be adapted to that of the chromatograph, so that there is no internal overpressure which could decrease the flow of the reagents with the subsequent appearance of a precipitate of La(OH)₃. These different flow-rates could also be responsible for retentions and high pressures in the chromatographic system. Therefore, once the system is set in motion, the flow-rate of the chromatograph must be measured and adjusted to the optimised value (see above). The best value is 1.25 mL min⁻¹. The flow-rate of the FI system equals that of the chromatograph by adjusting the pump speed; in that way, the initial condition of the method does not suffer important modifications.

The sample volume injected in the IC exerts a major influence on the response given by the FI system. The loops used in the chromatograph and the FI system as well as the reactor lengths are optimised by carrying out assays with HAC standards (concentrations 0, 0.5 and 1.0 g l⁻¹) in distilled deionised water. The results are shown in Table V.

The sensitivity of the chromatograph must be adapted to the conductivity of each analyte according to the concentration of the samples. The sensitivity was then optimised for each type of injected sample; it turned out to be 300 µS in all instances.

Table V
Results of the optimisation of the IC-FI variables for Ac⁻ determination

	Pressure (bar)	Injected Vol. IC (µL)	Injected Vol. FI (µL)	R ₁ (cm)
Range	27-50	50-200	14-200	0-200
Optimum	45	150	60	0*

* 86 cm minimal distance between the IV position and the detector (Fig. 3)

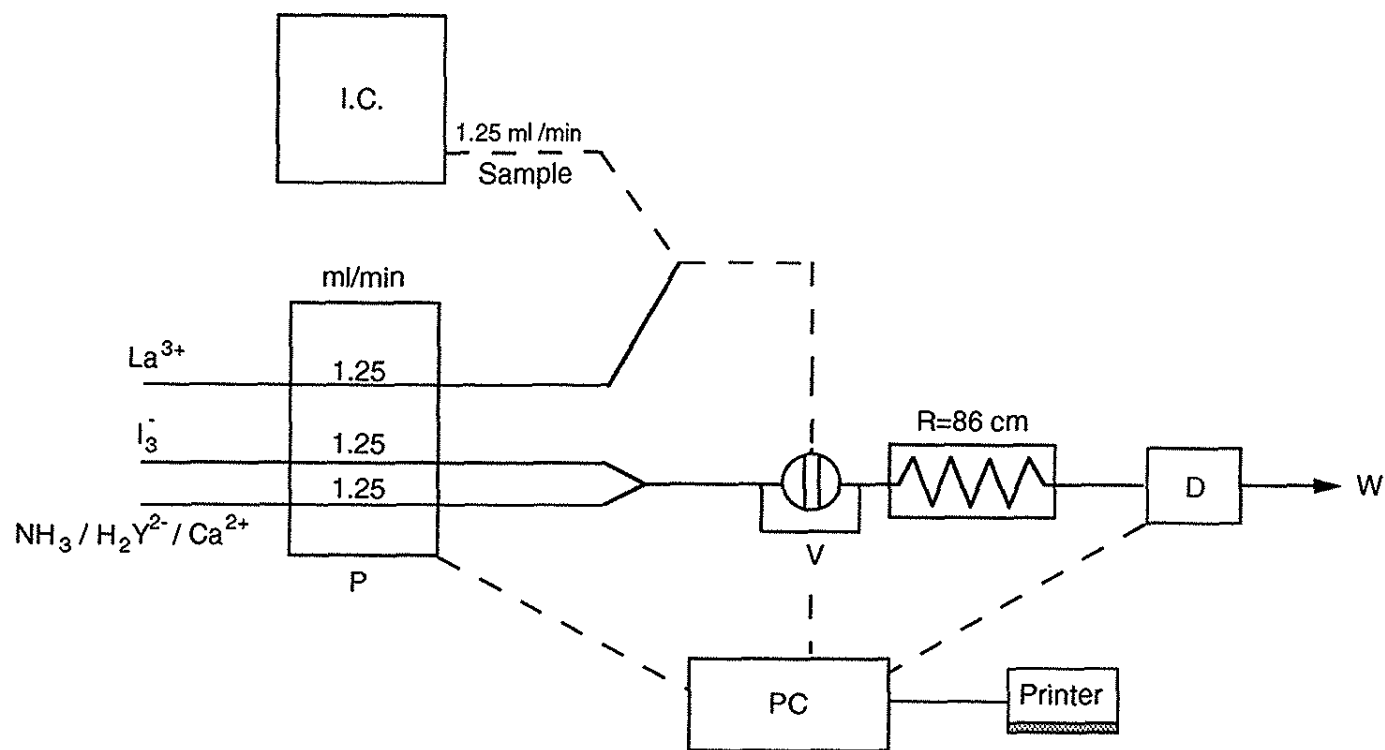

Figure 3. IC-FI configuration for the determination of acetate.
 IC- ionic chromatograph; P- pump; V- automatic injection valve; PC- computer; R- reaction coil (thermostated at 30 °C); p- printer; D- detector; W- waste.

E. Esteve-Juan, R. Puchades & A. Maquieira

The optimised $\text{Na}_2\text{CO}_3/\text{NaHCO}_3$ solution was used as chromatographic eluant and this does not offer any problem inside the FI system, as it is only a carrier.

In order to determine the concentration of acetate, a calibration graph was run with HAC standards in the artificial matrix diluted 1:5 with distilled deionised water. These standards covered the range between 0 and 1 g l^{-1} . The result in absorbance and area was: $\text{Abs} = 0.704 - 0.117(\text{HAc})$ ($r=0.9916$).

Application to real samples

The proposed method was applied to the determination of acetate in mustard sauce. $0.6 \text{ mM CO}_3^{2-}/1.7 \text{ mM HCO}_3^-$ was used as eluant and the extracts were diluted 1:5 with distilled deionised water.

According to the developed method, the concentration of acetate was evaluated by means of the post-column coupled FI method.

The results obtained with both the proposed and the reference method are very similar. The mean values for mustard sauce obtained by FI-IC and the distillation reference method are 23.6 and 23.3 g K^{-1} , respectively with a recovery of 98.7%. Furthermore, the chromatographic method allows for the simultaneous analysis of other anions which are present in the samples such as nitrate, phosphate, sulphate and so on. The usefulness of the method is then demonstrated.

CONCLUSIONS

The IC-FI coupling widens the application field of IC. The specificity in the analysis of ionic species increases, as well as the resolution of mixtures of ions which co-elute. Its application to real samples has been satisfactory, although there is still much to do with matrices other than those assayed.

With this method, acetate can be determined in complex samples in the presence of other ionic compounds.

The IC-FI coupling permits the use of an identification reaction for acetate (theoretically unspecific) with good results in the presence of potentially interfering anions such as Cl^- .

The advantages of this method are: simultaneous determination of several anions; detection limits of mg l^{-1} ; reduction of the time of analysis to minutes; minimum sample preparation; use of unexpensive reagents at very low concentrations and easy analysis of anions in complex matrices.

Acknowledgements. This research was supported by the CICYT, project ALI 90/0633. The authors acknowledge the financial aid.

REFERENCES

1. H. Small, T.S. Stevens and W.C. Bauman, *Anal. Chem.*, 47,1801 (1975).
2. D.T. Gjerde and J.S. Frith, "*Ion Chromatography*", 2nd edition, Hüthing, Heilderberg, (1987).
3. R.E. Smith, "*Ion Chromatography Applications*", CRC Press, Boca Raton, (1988).
4. O.F.X. Donard and F.M. Martin, *TrAC*, 11, 17 (1992).
5. G. Redant, *TrAC*, 11, X (1992).
6. I.S. Krull, "*Reaction Detection in Liquid Chromatography*", Marcel Dekker, New York, (1986).
7. M.D. Luque de Castro and M. Valcárcel, *J. Chromatogr.*, 600, 183 (1992).
8. H. Engelhardt, R. Klinkner and G. Schöndorf, *J. Chromatogr.*, 535, 41 (1990).
9. O.N. Obrezkov, V.I. Shlyamin, O.A. Shpigum and Yu.A. Zolotov, *Anal. Sci.*, 7, 321 (1991).
10. S.A. Kupina, J.L. Kutchnski, R.D. Williams and R.T. De Soto, *Am. J. Enol. Vitic.*, 33, 67 (1982).
11. A. Schneider, V. Gerbi and M. Redoglia, *Am. J. Enol. Vitic.*, 38, 151 (1987).
12. V. Heidger, *Weinwirtschaft-Technik*, 126, 12 (1990).
13. S. Pro-Labrandero, "*Desarrollo de un sistema de adquisición de datos y control para su utilización en métodos analíticos en flujo (FLA)*". Proyecto Fin de Carrera. E.T.S.I.I. Universidad Politécnica de Valencia. Valencia. (1993), 300pp.
14. L. Canalé-Gutiérrez, A. Maquieira and R. Puchades, *Analyst*, 115, 1243 (1990).
15. M. Pesez and J. Bartos, "*Colorimetric and Fluorimetric Analysis of Organic Compounds and Drugs*", Marcel Dekker, New York, (1974).
16. F. Pino-Pérez and M. Valcárcel-Cases, "*Equilibrios iónicos en disolución. Análisis volumétrico*", Urmo S.A. Ediciones, Bilbao, (1978).
17. A.I. Vogel, "*Vogel's textbook of macro and semimicro qualitative inorganic analysis*", 5th edition, Longman, New York, (1979).
18. D.L. Massart and A. Dijkstra, "*Evaluation and Optimization of Laboratory Methods and Analytical Procedures*", Part 2, Elsevier, New York, (1988).
19. F. Bermejo-Martínez, in: "*Chelates in Analytical Chemistry*", H.A. Flaschka, A.J.Jr. Barnard (Ed.), Vol.5, Part D, Marcel Dekker, New York, (1976).
20. F.A. Cotton and G. Wilkinson, "*Advanced Inorganic Chemistry*", 4th edition, John Wiley and Sons, New York, (1980).
21. J. Ribéreau-Gayon, E. Peynaud, P. Sudraud and P. Ribéreau-Gayon, "*Traité d'oenologie. Sciences et techniques du vin*". Tome 1, Dunod, Paris, (1976).

CHARACTERIZATION OF
GEOCHEMICAL PARAMETERS OF AN
ORGANIC SOIL FROM TERRA DE
AREIA, NORTHERN COASTAL PLAIN,
RIO GRANDE DO SUL, BRAZIL.

Adriana Olmos da Rocha and Paulo César Pereira das Neves*
Museu de Ciências - Departamento de Química
Centro de Ciências Naturais e Exatas - CCNE
Universidade Luterana do Brasil - ULBRA
Rua Miguel Tostes, 101 - CEP 92420-280, Canoas, RS, Brasil.

ABSTRACT

Sixteen samples of organic soil from a wetland, collected at a depth of 0.30 m, at a distance of 4 km from the town of Terra de Areia in the Northern Coastal Plain of Rio Grande do Sul were analyzed and studied, for the presence of various metals, nitrogen, phosphorus, organic carbon, sulfur, humidity, ashes and heat content. The exact location of the sampling corresponds to Latitude 29°33'04''S; Longitude 50°03'25''W. On the basis of the experimental results obtained for organic carbon, ash and heat content it may be concluded that the site is not a turfland. On the other hand, metal and flux analysis gave information about the evolution of the site and may be important from an ecological viewpoint.

Keywords: Turfland, Wetland, Soil Samples, Geochemical Analysis.

RESUMO

Dezesseis amostras de solo orgânico, provenientes de um banhado, coletadas a 0,30 m de profundidade, localizado numa distância de aproximadamente 4 km da cidade de Terra de Areia, Planície Costeira Norte do Rio Grande do Sul, foram analisadas e estudadas, em relação a presença de vários metais, nitrogênio, fósforo, carbono orgânico, enxofre, umidade, cinzas e poder calorífico. A exata localização da amostragem, corresponde a Latitude 29°33'04''S; Longitude 50°03'25''W.

*Author to whom correspondence should be addressed.

Com base nos resultados experimentais obtidos para carbono orgânico, cinzas e poder calorífico, pôde-se concluir que o local não corresponde a uma turfeira. De outro modo, as análises de fluxo de metais trazem importantes informações sobre a evolução do ambiente a partir de um ponto de vista ecológico.

INTRODUCTION

The lack of major integrated studies of environmentally protected areas in Brazil, involving botany, zoology, geography, geology and chemistry has led to bad uses of large areas of land. Mismanagement and lack of law enforcement have resulted in the destruction and abandonment of vast areas of Mata Atlântica (Atlantic Rain Forest), an important sanctuary of many species.

In order that such environments that we have inherited from nature may be available to future generations it is imperative that they be studied interdisciplinarily and preserved.

Wetlands and turflands contain a very rich biodiversity, but it is very susceptible to environmental changes. The great majority of studies done so far were in the Northern Hemisphere (Finland, Soviet Union, United States, Canada) and dealt with ecological relationships, energetic or agricultural potentials¹.

In Brazil, the first significant studies were done by Villwock and coworkers² in 1979 and concerned geochemical characterization of the deposit of Águas Claras in the city of Viamão, Rio Grande do Sul. In the same year, the Instituto de Pesquisas Técnicas - IPT of the State of São Paulo published a report on studies done with turf, particularly analysis of hydrogen, nitrogen, oxygen, ashes, organic matter, carbon and some metals³.

In 1981 Lemos and coworkers studied some turf deposits from the state of Paraná and discussed heat content, sulfur and acidity⁴. Lima and his coworkers published in 1982 an energetic characterization of turf from the Brazilian Coast in the states of Bahia and Sergipe and reported results for humidity, heat content and sulfur⁵. In 1983 Füller⁶ studied the possible energetic use of peat from Salvador, Bahia; Campos, Rio de Janeiro and São José dos Campos, state of São Paulo. In 1985 Kiehl⁷ reported results of nitrogen and pH studies in peat from the state of São Paulo. SANTOS⁸ measured physical-chemical parameters and age of humic acids for peat from the margins of the Mogi-Guaçu River, state of São Paulo. In 1989 Roth⁹ analyzed palinologically turf from the Parque Nacional de Aparados da Serra, Cambará do Sul, state of Rio Grande do Sul. In 1991 Neves¹¹ published results of a palinologic study in the region of Terra de

Areia, state of Rio Grande do Sul and also gave a detailed botanical and geological description of the site studied.

The purpose of the present work is to perform a geochemical characterization of organic soils from a wetland in Terra de Areia, Northern Coastal Plain in the state of Rio Grande do Sul and to obtain a better knowledge of this ecosystem.

DESCRIPTION OF THE SITE

The site under consideration is situated in town of Terra de Areia, Northern Coastal Plain in the state of Rio Grande do Sul, Brazil. It consists of a wetland located in a filled depression of an old pleistocene beach ridge near the volcanic rocks of Serra Geral Formation (Lat. 29°33'04''S; Long. 50°03'25''W). A geologic map of the microregion is given in Figure 1. The extremities of wetland are surrounded altered sand fields that represent the highly eroded crests of an old pleistocene beach ridge.

CLIMATE

The climate of the Northern Coastal Plain of Rio Grande do Sul is generally considered mildly mesothermic and very humid¹⁰. According to data provided by IPAGRO¹⁶ the average annual temperature is 19.8°C. In January, the hottest month of the year, the average is 24.4°C, whereas in June, the coldest month, it is 15.4°C. The mean annual relative humidity is 79 per cent and the mean annual precipitation is 1676.5 mm. There are about 123 rainy days per year. The evaporation rate is 1094.1 mm/yr. The winds are mainly southeasterly and at times southwesterly with an average velocity of 20 m/s. Because of the proximity of the Serra Geral Formation, rain storms are common, due to hot air masses that come from the Atlantic Ocean and reach the slopes of the mountains. The climatic conditions explain the hydric excess and importance of the rain for the maintenance of the hydrographic conditions of the site and the development and maintenance of the ecosystem and low land vegetation of the region.

VEGETATION

A general view of the site under consideration is given in Figure 2 and some typical local vegetation is shown in Figure 3. The vegetation of the microregion can be considered of three basic types: a forest with tropical characteristics, a wetland and an altered sandy terrain. A

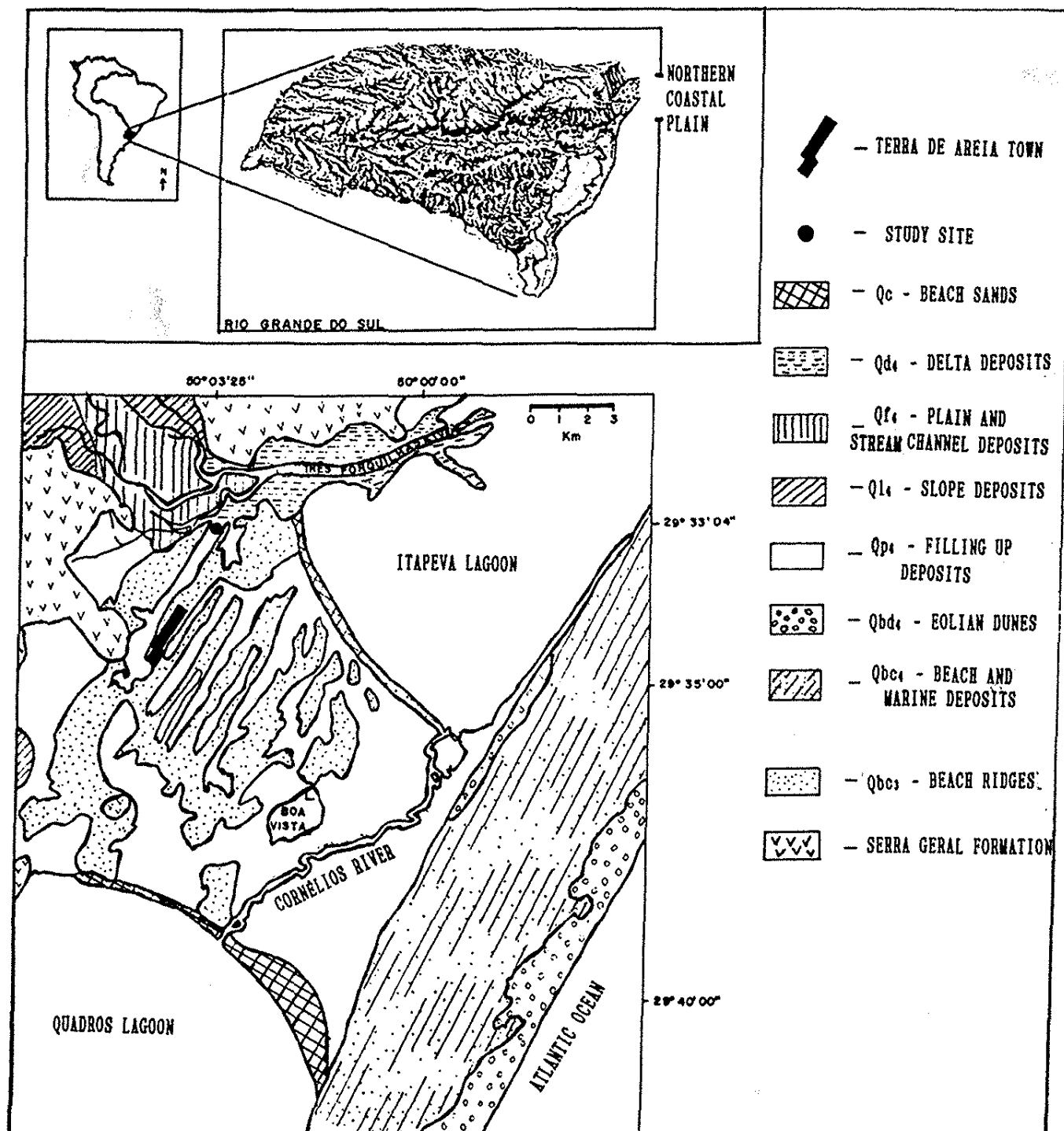

FIGURE 1. GEOLOGIC MAP OF THE MICROREGION STUDIED (ACCORDING NEVES AND LORSCHREITER^{1,2}).

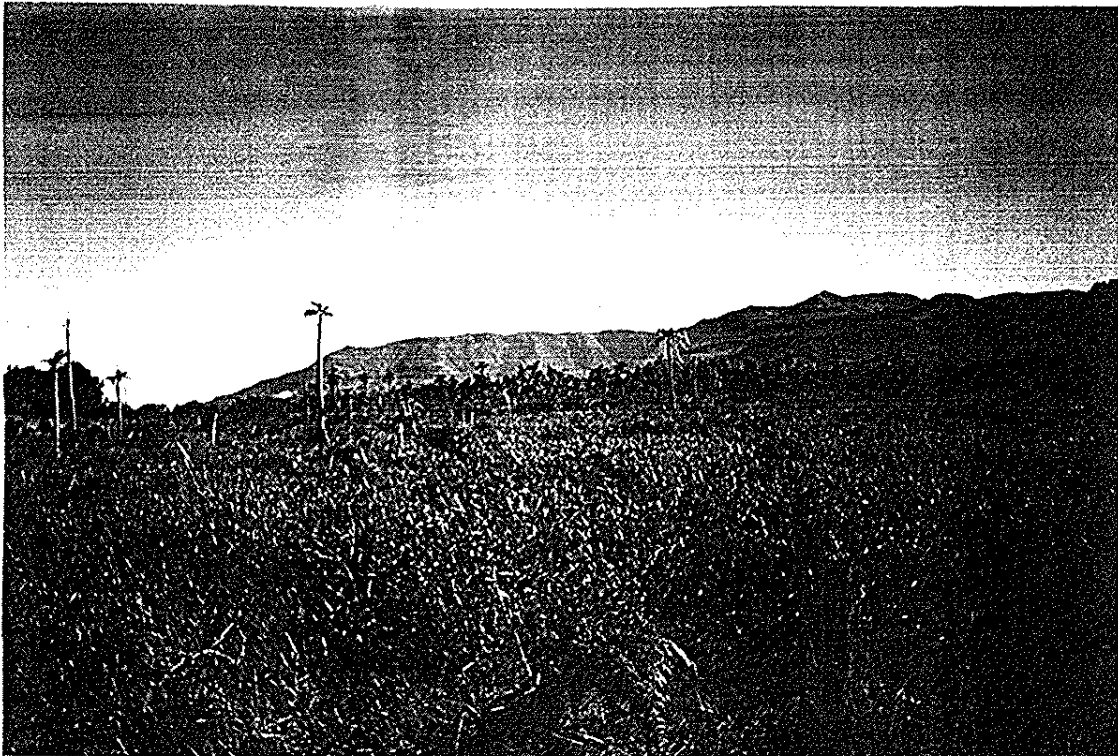

FIGURE 2. GENERAL VIEW OF THE SITE STUDIED (SERRA GERAL FORMATION IN THE BACKGROUND Qp₄ FACIES).



FIGURE 3. SOME ASPECTS OF THE VEGETATION OF THE MICROREGION STUDIED (Qp₄ FACIES).

detailed description has been given by Neves and Lorscheitter¹³.

The forest contains a large number of tropical species including: *Rodriguezia decora* Rchb. f. and *Pleurothallis* spp. (Orchidaceae); *Vriesea rodigasiana* E. Morr., *Nidularium innocentii* Lem. and *Tillandsia usneoides* (L.) L. (Bromeliaceae); *Philodendron* aff. *imbe* (Schott) Schott (Araceae); *Geonoma schottiana* Mart., *Bactris lindmaniana* DR. and *Syagrus romanzoffiana* (Cham.) Glassm. (Arecaceae) and *Smilax quinquenervia* Vell. (Smilacaceae).

Close to the forest there is swampy portion without trees containing: *Spagnum* spp. (Sphagnaceae); *Scirpus* cf. *giganteus* Kunth (Cyperaceae); *Baccharis* spp. (Asteraceae); *Leandra australis* (Cham.) Cogn. (Melastomataceae); *Syngonanthus crysanthus* (Bong.) Ruhl (Eriocaulaceae); *Schizachyrium* sp. (Poaceae); *Ilex pseudobuxus* Reiss. (Aquifoliaceae); *Gomidesia palustris* (DC.) Legr. (Myrtaceae); *Vernonia puberula* Less. (Asteraceae); *Ludwigia caparosa* (Camb.) Hara (Onagraceae); *Syagrus romanzoffiana* (Arecaceae) and *Coussapoa microcarpa* (Schott) Rizz. (Cecropiaceae).

To the north there is a wetland formed by the delta system of Três Forquilhas River. This wetland is characterized mainly by the presence of aquatic macrophytes such as: *Pontederia lanceolata* Nutt. and *Eichhornia azurea* Kunth (Pontederiaceae); *Sagittaria montevidensis* (L.) Cham. et Schlecht. (Alismataceae); *Senecio bonariensis* Hook. et Arn. (Asteraceae); *Ludwigia caparosa* (Onagraceae); *Myriophyllum brasiliense* Cambess. (Haloragaceae); *Eryngium pandanifolium* Cham. & Schelecht. (Apiaceae) and *Azolla* spp. (Azollaceae).

The altered sandy terrain that is higher (Qbc₃ facies) contains: *Eriochrysis cayennensis* Beauv., *Andropogon bicornis* L. and *Briza erecta* Lam. (Poaceae); *Sida cordifolia* L. (Malvaceae); *Asclepias curassavica* L. (Asclepiadiaceae); *Lantana camara* L. (Verbenaceae); *Pteridium aquilinum* (L.) Kuhn (Dennstaedtiaceae); *Bidens pilosa* L., *Baccharis* spp., *Hipochaeris* sp., *Orthopappus angustifolium* Gleason and *Simphyopappus casarettoi* B. L. Robynson (Asteraceae); *Desmodium ascendens* (Sw.) DC. (Fabaceae); *Dodonaea viscosa* Jacq. (Sapindaceae); *Mimosa bimucronata* Kuntze (Mimosaceae); *Jacaranda puberula* Cham. (Bignoniaceae); *Butia capitata* Becc. (Arecaceae) and *Pseudobombax grandiflorum* (Cav.) A. Robyns (Bombacaceae), and other cultivated species.

GEOLOGICAL DATA

The town of Terra de Areia, where the site under study is located is according to Villwock¹⁴ part of the Coastal Geologic Province of Rio Grande do Sul. The geological

mapping contains the Qbc₃ and Qp₄ facies. The Qp₄ facies, where the samples for the present study were collected contains a lagoon and fluvial deposits that came to fill the pre-existing depressions among the crests. The elastic particles of these deposits are generally rounded with medium sphericity and smooth polished surfaces. They contain quartz, muscovite, chalcedony, feldspar, a small quantity of heavy minerals and significant amounts of organic matter¹⁷. Along the Northern Coastal Plain this facies is many times related to peat and clay deposits. These mire deposits of the area seem to be related to former lagoon land forms and never attain a large superficial extension. They originated from a progressive filling of isolated lagoon bodies in old beach ridge depressions. Results of ¹⁴C dating by NEVES¹¹ show that the beginning of the sedimentation of these deposits date to 23,800 ± 500 yrs B. P., corresponding to the last glacial stage of the Pleistocene.

MATERIAL AND METHODS

The choice of the study site took into account primarily the good environmental preservation of the medium and the presence of organic soil adequate for analysis. The main purpose was to obtain analytical data free of external interference.

Sixteen different samples of organic turf soil were collected at a depth of 0.30 m and at distances of about 20 m between the various sampling points. The samples were collected on May 3, 1995. In a previous study dealing with the sedimentological characterization we have shown that superior horizon of the wetland has the most pronounced turf characteristics¹². A diagram illustrating the collection points at the site is shown in Figure 4.

In order to obtain representative samples for analysis and correct for edaphic variations the sixteen samples were subdivided in to two groups and designated 1A to 8A and 1B to 8B, respectively.

Samples 1A to 8A were analyzed in the COPESUL Laboratory in Triunfo, RS. They were dried for approximately 16 hours until reaching a constant weight. The samples were then digested with nitric and hydrochloric acids. The analysis for metals was performed using a Plasma ICAP Spectrometer. The analysis for ash content was done by heating at 750°C for one hour followed by mass difference. The hygroscopic humidity and the heat content were determined at 105°C according to standard methods described for mineral coal following Brazilian Norms (ABNT - MB15).

Samples 1B to 8B were dried to a constant weight at 40°C and subsequently analyzed in the Soil Chemistry

Laboratory of Universidade Federal do Rio Grande do Sul in Porto Alegre.

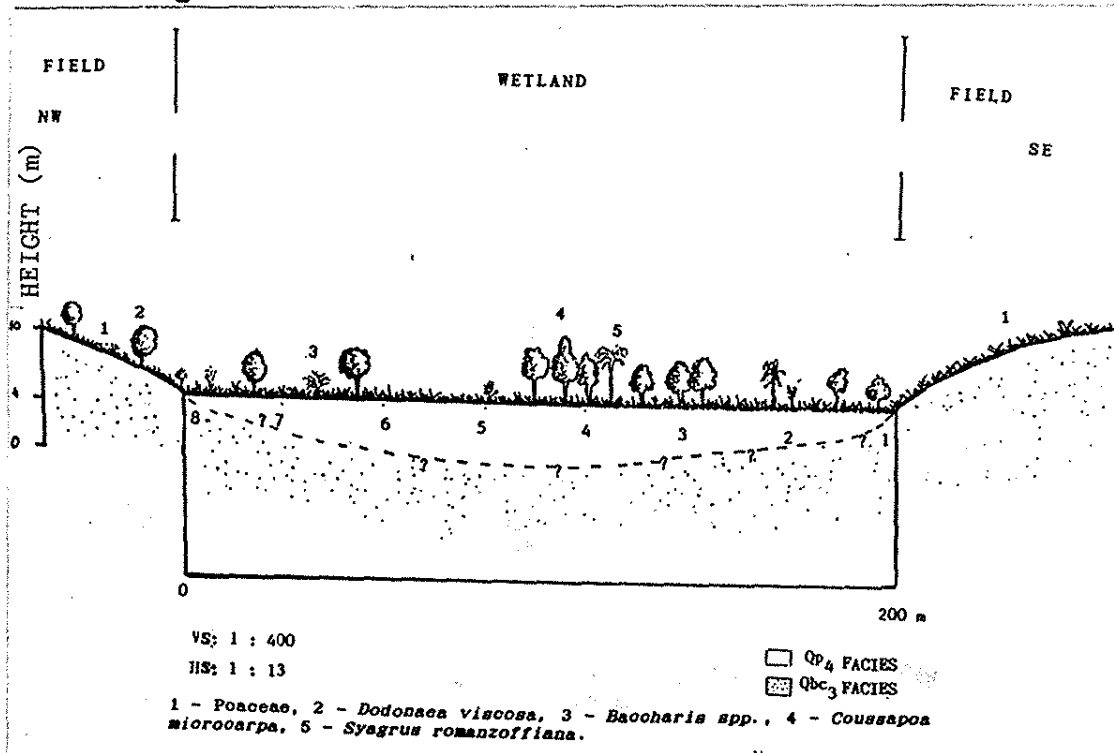

FIGURE 4. DIAGRAM ILLUSTRATING SAMPLING POINTS AT THE SITE STUDIED.

They were subjected to mechanical milling prior to analysis and digested with hydrogen peroxide and sulfuric acid. The nitrogen determination was performed using the Kjeldahl method with the modifications described by Tedesco and coworkers¹⁵. The digestion temperature was increased by the addition of sodium sulfate. Phosphorus was analyzed by flame spectrometry using ammonium molybdate and 1-amino-2-naphthol-4-sulphonic acid. The analysis of Cu and S was done by atomic absorption spectrometry, after digestion of the samples with nitric and perchloric acids. The analysis for Ni was performed by flame photometry after extraction with 0.1 N HCl. The content of organic carbon was done following a method described by Tedesco and coworkers¹⁵.

RESULTS AND DISCUSSION

The results obtained for N, P, Cu, organic C, S and Ni are summarized in Table I. The content of organic carbon exhibited almost uniform values and varied from 30 per cent by weight (sample 2B) and 37 per cent by weight (sample 6B).

TABLE I. CHEMICAL ANALYSIS OF SOIL SAMPLES FOR N, P, Cu, S, Ni AND ORGANIC CARBON.

SAMPLES	1B	2B	3B	4B	5B	6B	7B	8B
Nitrogen %	2.0	1.7	1.7	1.7	1.4	1.7	2.0	1.7
Phosphorus %	0.13	0.13	0.08	0.08	0.06	0.07	0.07	0.07
Copper-ppm	17	20	15	17	12	12	9	20
Organic C %	31	30	32	33	35	37	35	32
Sulfur %	0.39	0.33	0.28	0.25	0.24	0.29	0.44	0.37
Nickel-ppm	15	16	11	8	8	3	4	9

TABLE II. SOME GEOCHEMICAL CHARACTERISTICS OF SOIL SAMPLES.

SAMPLES	1A	2A	3A	4A	5A	6A	7A	8A
Hygroscopic humidity %	8.5	7.9	8.2	8.6	8.4	8.6	7.6	8.2
Ash in humid base %	28.2	35.8	33.5	23.6	18.2	16.4	20.4	29.5
Heat content cal/g	3100	2900	2800	3400	3400	3900	3600	3100
Silicon-ppm	5890	1320	7060	1650	1160	1840	2020	3800
Sodium-ppm	425	190	316	227	96	140	136	166
Iron-ppm	13960	10570	6320	4450	2620	2750	2190	3080
Aluminium-ppm	19475	17560	11240	9900	7860	6450	6120	11160
Calcium-ppm	7210	4530	4660	3720	3220	3510	3940	3500
Magnesium-ppm	2080	1500	1310	1010	830	890	1140	910
Potassium-ppm	680	490	370	234	206	213	270	274
Ca/Mg-ppm	3.46	3.02	3.55	3.68	3.89	3.94	3.45	3.84

% by weight;
Samples collected in Terra de Areia on May 3, 1995.

Nitrogen varied from 1.4 per cent by weight (sample 3B) to 2 per cent by weight (samples 1B and 7B). Sulfur ranged from 0.24 per cent (sample 5B) to 0.44 per cent (sample 7B). The values obtained for phosphorus varied from 0.24 per cent to 0.44 per cent by weight. The results for copper ranged from 9 ppm (sample 7B) to 20 ppm (samples 2B and 8B) while those of Ni exhibited minimum and maximum values between 3 ppm (sample 5B) and 16 ppm (sample 2B).

Table II summarizes the experimental results obtained for K, Mg, Ca, Al, Fe, Na and Si. It also contains results obtained for the heat content, ashes in dry and wet base and hygroscopic humidity.

The elements Na, K, Mg and Ca showed values that ranged from (96, 206, 830 and 3220 ppm - sample 5A) to (425, 680, 2080 and 7210 ppm - sample 1A), respectively. Aluminium and iron exhibited the lowest values in sample 7B (6540 and 2750 ppm) and the highest values in sample 1A (19475 ppm and 13960 ppm), respectively. Silicon ranged from a minimum of 1160 ppm (sample 5A) to 7060 ppm (sample 3A). The heat content ranged from 2800 cal/g (sample 3A) to 3900 cal/g (sample 6A). The ash content in dry and wet base varied from 17.9 and 16.4 per cent by weight (sample 6A) to 38.9 and 35.8 per cent (sample 2A), respectively. The hygroscopic humidity ranged from 7.2 per cent to 8.6 per cent in samples 4A and 7A, respectively.

The soil studied was formed in an environmental with high humidity by the accumulation of organic matter of plant origin. There were also external contributions both mineral (sedimentary transport) and of plant origin (invasion by plants of the depression while it was being filled). The mineral matter may also have come from decomposition of plants that contain on the average about 6 per cent of the same (closed geochemical cycle). It may have also come in solution or suspension in the feeding waters or by eolic means.

The carbon present in these soils increases linearly with the degree of humification of the filling material. This is due to the formation of more complex carbon compounds that in turn depend on the nature of vegetation that gave rise to the soil. In the case of slow deposition, lignin and cellulose play an important role in this process. When this organic matter containing C, H, N, O and S is subject to combustion it liberates heat, that is called the heat content. The heat content determination and the amount of organic carbon present allows the classification as peat or peat sediment.

The experimental results obtained indicate a good correlation between heat content and ash content determined. Figure 5 illustrates this correlation. As expected, samples with the highest heat content exhibited the lowest ash content.

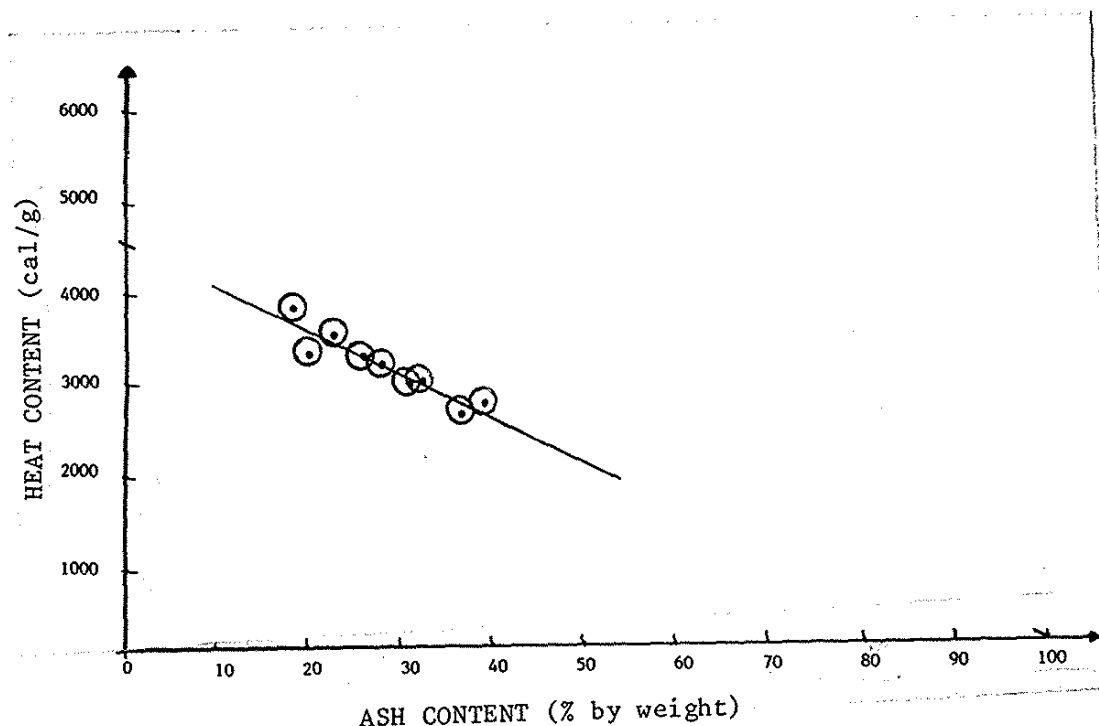

FIGURE 5. CORRELATION BETWEEN HEAT AND ASH CONTENT FOR THE SOIL SAMPLES STUDIED.

The humidity determined at 105°C is compatible with this type of soil and exhibits higher values in the samples collected near creeks, and lower values elsewhere, indicating a major compactation of the material and increase in clay minerals at these sites.

The sulfur content was rather low. This is explained by the lack of direct marine influence and the plant organic origin of the sulfur.

The nitrogen present in these soil is essentially the result of decomposition of plant proteins.

Phosphorus is mainly present as phosphate and it is related to fertilizing properties.

Typical turfland studies suggest concentrations of N, S and P of the order of 1, 0.25 and 0.1 per cent, respectively¹. Nitrogen may reach up to 4.5 per cent and S may vary from 0.5 to 5 per cent, depending on the degree of humification. The soil under consideration comes from a wetland and it has a low degree of humification.

The Cu content of soils from Southern Brazil varies from 0.1 to 5 ppm¹⁵. The higher contents found in the present study are due to soil retention. The Cu distribution clearly follows the pattern of drainage of the site of study.

Nickel is not essential for the growth of plants, is therefore not bioaccumulated and its concentration usually follows that of ashes¹. The present study did not allow as to conclude whether Ni is due to pollution or simply the entry of mineral matter.

Sodium and potassium are highly soluble monovalent cations, are easily lost by soils because they form weak organic complexes and are usually present in low concentrations. The bioaccumulation of K is due to plant degradations while Na, that is not essential for plants, is usually transported by water. The low concentration of both ions in wetlands is most likely a direct consequence of drainage.

Magnesium and calcium are divalent cations that form unstable organic complexes; Ca appears to be essential to plant growth and the usual Ca/Mg ratio¹ for fresh waters is 3:1 and both are retained. The ratios measured in this study agree with this observation and ranged from 3.02 to 3.84. All the ions mentioned so far including Mg⁺⁺, Ca⁺⁺, Na⁺, Ni⁺⁺⁺ and Cu⁺⁺ reflect drainage conditions of the site.

The soils that we studied are acid soils (pH of percolation waters is about 3.5) and this factor is very important in the consideration of ionic species of Al and Fe. Ions such Al⁺⁺⁺ and Fe⁺⁺⁺ are toxic to plants and become soluble below pH 5. On the other hand Fe⁺⁺ is essential for plants but is oxidized to Fe⁺⁺⁺ in marshy environments. In this case, its availability to plants depends essentially on the pH and the oxidation conditions of soils¹. The presence of iron leads to the acidification of waters and is inversely proportional to water flow, following the same pattern as of the percentage of saturation with oxygen. Both Al and Fe are retained by these soils.

In other type of soils Si in the form of SiO₂ varies normally from 240000 to 330000 ppm. In our case, where we dealt with an organic soil the Si content was much lower (1160 to 7060 ppm). The Si content is directly related to ash content and inversely related to heat content.

The present study allows as to reach the following conclusions:

- the choice of the site of study was adequate and permitted a good geochemical characterization of the sediments;

- there was good agreement between our results and results reported in the literature for similar soils;

- the site studied cannot be classified as a turfland based on the heat content, ash content and organic carbon. Usually the requirements for such classification are a heat content above 3500 cal/g, organic carbon above 60 per cent and ash content lower than 35 per cent by weight;

- the results of the elements analyzed although giving slightly different values from those reported in the literature, follow the same pattern and permit us to suggest that the site will become a turfland in the geological future;

- the pattern of water drainage is in agreement with the metal concentration determined at the different sites of the wetland;

- the study was significant in terms of hydrological and environmental aspects and provides knowledge for a better preservation of this important coastal ecosystem.

REFERENCES

1. W. Shotyk. Reviews of the Inorganic Geochemistry of peats and peatland waters. *Earth Sc. Rev.*, Amsterdam, 25, 95-176 (1988).
2. J. A. Villwock, E. A. Denhardt, E. Loss and T. Hofmeister. *Turfas na Província Costeira do Rio Grande do Sul: Geologia do Depósito de Aguas Claras*. Instituto de Geociências - UFRGS, Porto Alegre, 1979.
3. Relatório nº 12761. *Estudo das possibilidades de aproveitamento de Turfa no estado de São Paulo*. IPT - São Paulo, Vol. 1, 1979.
4. V. B. Lemos, K. Siedlercki, M. L. Lorscheitter and L. Lamb. *Considerações preliminares quanto à prospecção de áreas turfosas*. In: 3º Simpósio Regional de Geologia, Curitiba, Paraná, Vol. 2, 1981.
5. R. C. Lima, I. V. G. Costa, J. F. Silva and A. J. D. Rocha. *Turfas na Faixa costeira Bahia-Sergipe*. In: Congresso Brasileiro de Geologia, Vol. 5, Salvador, 1982.
6. O. Füller. *Relatório Goodwin*. Consultoria canadense sobre turfás. CPRM, Rio de Janeiro, 1983.
7. E. Kihel. *Aproveitamento de turfás na agricultura - Caracterização e influência nas propriedades do solo*. Anais de Seminário sobre turfa, Prospecção e usos. Campanha Energética - IPT. São Paulo, 1985.
8. A. Santos. *Caracterização físico-química e idade de ácidos húmicos extraídos de turfeiras das margens do rio Mogi-Guaçu (São Paulo, Brasil)*. Dissertação de Mestrado em Físico-Química, Universidade de São Carlos, São Carlos. 1990, 69 pp.
9. L. Roth. *Palinologia de sedimentos de uma turfeira do Parque Nacional de Aparados da Serra, Planalto Leste do Rio Grande do Sul, Brasil*. Dissertação de Mestrado em Ciências, Universidade Federal do Rio Grande do Sul, Porto Alegre, 1990, 223 pp.
10. E. Nimer. *Climatologia do Brasil*. 2ª ed., IBGE, Rio de Janeiro, 1979, 422 pp.

11. P. C. P. das Neves. *Palinologia de sedimentos de uma mata tropical paludosa em Terra de Areia, Planície Costeira Norte, Rio Grande do Sul, Brasil*. Dissertação de Mestrado em Geociências, Universidade Federal do Rio Grande do Sul, Porto Alegre, 1991, 227 pp.
12. P. C. P. das Neves and M. L. Lorscheitter. Upper Quaternary palaeoenvironments in the Northern Coastal Plain of Rio Grande do Sul, Brazil. *Quaternary of South America and Antarctic Peninsula*, Rotterdam, 9: 39-67, (1995).
13. P. C. P. das Neves and M. L. Lorscheitter. Feições de uma mata tropical paludosa em Terra de Areia, Planície Costeira Norte, Rio Grande do Sul, Brasil. *Notas Técnicas, CECO-IG-UFRGS*, 9: 28-38, (1996).
14. J. A. Villwock. *Contribuição à Geologia do Holoceno da Província Costeira do Rio Grande do Sul*. Dissertação de Mestrado em Geociências, Universidade Federal do Rio Grande do Sul, Porto Alegre, 1972, 133 pp.
15. M. Tedesco, S. Volkweiss and H. Bohnen. Análise de solos, plantas e outros materiais. *Boletim Técnico nº 5*, Departamento de Solos, Faculdade de Agronomia, UFRGS, Porto Alegre, 1995.
16. IPAGRO - INSTITUTO DE PESQUISAS AGRONÔMICAS. Observações meteorológicas no estado do Rio Grande do Sul. *Boletim Técnico do IPAGRO*, Porto Alegre, (3): 103-114, (1979).
17. N. O. Horn Fº. *Geologia das folhas de Torres, Três Cachoeiras, Arroio Teixeira e Maquiné, Nordeste do Rio Grande do Sul*. Dissertação de Mestrado em Geociências, Universidade Federal do Rio Grande do Sul, Porto Alegre, 1987, 254 pp.

**MATHEMATICAL CORRELATION BETWEEN MASS
TRANSFER COEFFICIENTS AND PARAMETERS INFLUENCING THE
PENICILLIN G REACTIVE EXTRACTION PROCESS**

Dan Cascaval, Corneliu Oniscu and Adina Dumitrascu

Technical University " Gh. Asachi " Jassy, Faculty of Industrial Chemistry,
Department of Organic Industries, Bd. Mangeron 71, 6600 - Jassy, Romania.

ABSTRACT. In this paper a correlation between the individual mass transfer coefficient of Penicillin G for the aqueous phase and two parameters of the reactive extraction process of Penicillin G with Amberlite LA-2, namely the extractant concentration in the organic phase, and the mixing intensity, was established. The proposed correlation offers a good concordance with the experimental values of the mass transfer coefficient and may be applied with a maximum error of 18 % and an average deviation of 1.6 %.

RESUMO

O presente trabalho estudou vários procedimentos para a extração da Penicilina G. Foram determinados parâmetros para o processo de extração reativa da Penicilina G com Amberlite LA-2, especificamente a concentração de extratante na fase orgânica e a intensidade de mistura. A correlação entre o coeficiente de transferência de massa da Penicilina G da fase aquosa e os dois parâmetros em acetato de butila também foi determinado. Esta correlação foi boa e pode ser aplicada com um erro experimental, máximo de 18% e um desvio padrão de 1,6%.

KEYWORDS : Penicillin G extraction, reactive extraction, Amberlite LA-2, mass transfer coefficients.

INTRODUCTION

The Penicillin G obtained by biosynthesis is separated from the aqueous phase by means of some laborious extraction and reextraction stages, resulting finally in an overall separation yield of 70 - 75 %.¹ In order to eliminate these shortcomings the authors have studied the possibility of the Penicillin G separation by means of other procedures, the reactive extraction among them. The conditions of the reactive extraction process have previously been established.^{2, 3} These studies have demonstrated the significant influence of the extracting agent concentration in organic phase and of the mixing intensity.

This paper is aimed to settle a correlation between the Penicillin G individual mass transfer coefficients and the variables influencing decisively the reactive extraction process (the extractant concentration value in solvent, the mixing intensity value) using an extractant of the Amberlite LA-2 type in butyl acetate medium.

EXPERIMENTAL

The laboratory equipment used (figure 1) consists of a glass column of 56 mm inner diameter and 180 mm height, provided with a jacket through which the thermosetting agent passes, namely water maintained at 25 °C by means of a thermostat. The two phases were mixed together by a vibratory mixer with a perforated disk of 45 mm diameter having a 17 % free section. The vibrations had a frequency of 50 Hz and a variable amplitude.

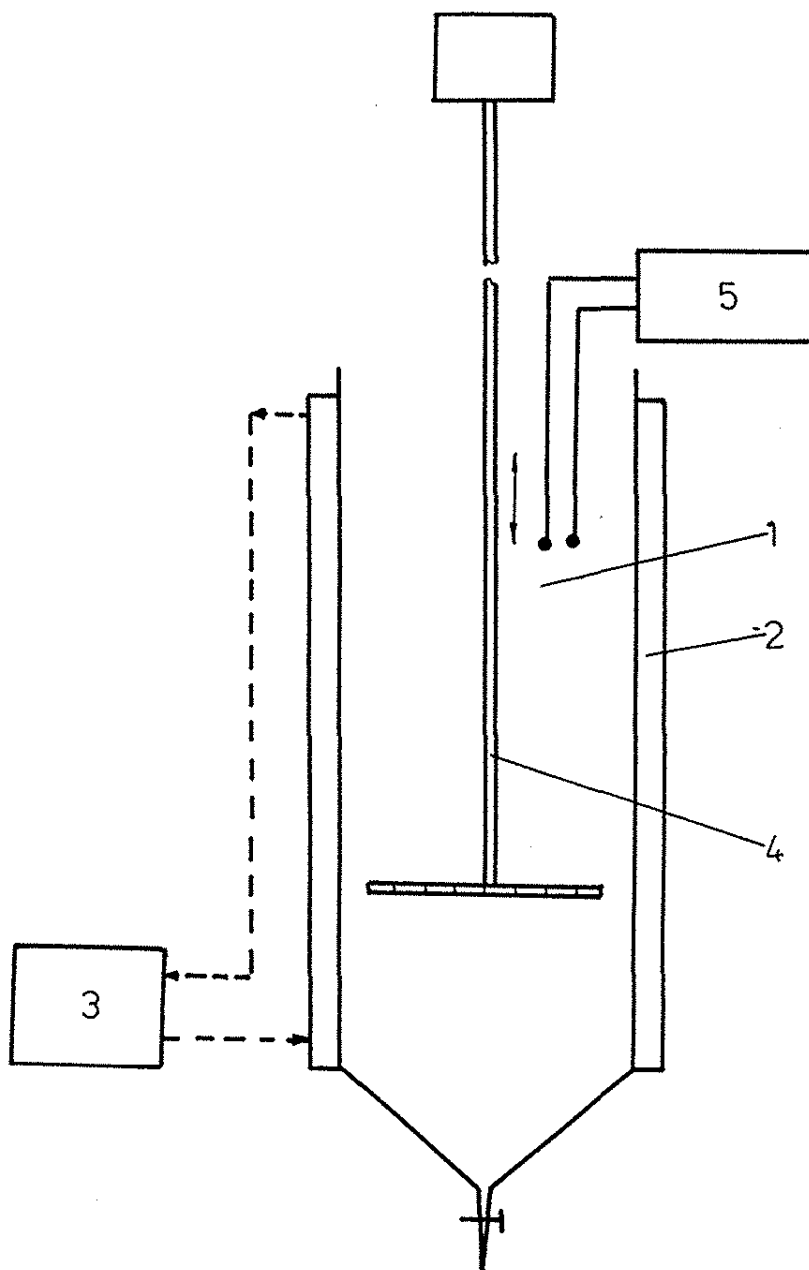

Figure 1. The experimental equipment. 1 - glass column; 2 - jacket; 3 - thermostat; 4 - vibratory mixer; 5 - pH-meter.

The resulting emulsion was separated in a centrifugal separator.

The experimental studies on Penicillin G reactive extraction were carried out in a batch system. In this work Penicillin G potassium salt was used. Its initial concentration in aqueous phase was of 7.7 g L^{-1} . The Amberlite LA-2 concentration values in butyl acetate phase was 64, 92 and 166 g L^{-1} . The volume ratio of organic phase and aqueous phase was 1 : 2, namely 50 mL solvent and 100 mL Penicillin G potassium salt aqueous solution.

The pH adjustment of the initial aqueous solution, at $\text{pH} = 3$, was made by means of 5 % sulphuric acid solution added in function of the prescribed pH - value measured by a digital pH - meter.

The intensity values of the two phases mixing, calculated by the relationship :

$$i = A \cdot f$$

was varied between 0.025 and 0.25 m s^{-1} .

The process development was followed by dosing the Penicillin G by the iodometric method.

RESULTS AND DISCUSSION

The separation process by reactive extraction can be controlled by diffusion or by the chemical reaction. The extraction rate determining step can be established by means of the influence of the mixing intensity on the reactive extraction yields, for a certain extracting agent concentration. The increase in the Penicillin G extraction yield with the increase in the mixing intensity value shows that the Penicillin G diffusion is separation rate determining step. For higher mixing intensity values the reactive extraction yield become almost constant, in this case the

chemical reaction being the determining step. The results obtained for three Amberlite LA-2 concentrations are plotted in Figure 2.

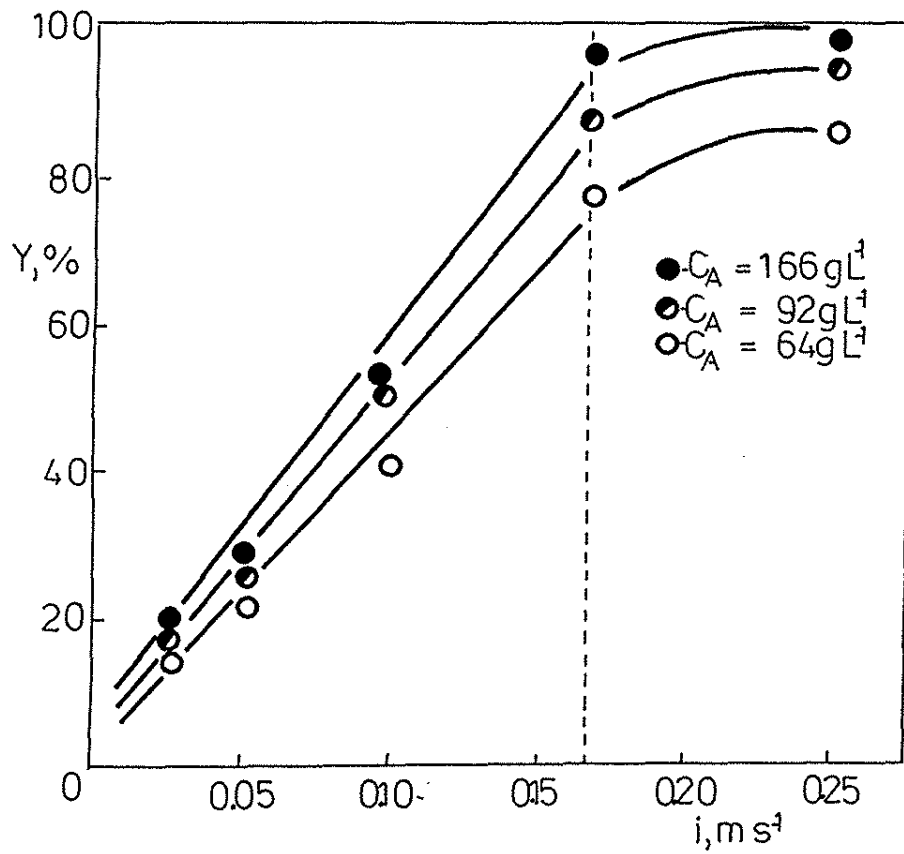

Figure 2. The reactive extraction yield versus mixing intensity.

As seen in Figure 2 the yield increases rapidly within the mixing intensity range $0.025 - 0.165 \text{ m s}^{-1}$, for any extracting agent concentration. For this intensity range the Penicillin G mass transfer is reactive extraction rate determining step. Over 0.165 m s^{-1} value the chemical reaction controls the separation process.

The correlation between Penicillin G individual mass transfer coefficients for the aqueous phase and Amberlite LA-2 concentration and mixing intensity was settled for the mixing intensity values bellow 0.165 m s^{-1} . The mass transfer coefficient values were calculated by the method proposed in previous papers.² Thus, by plotting $\ln C_p$ in function of extraction time for several mixing intensity values the straight lines have been obtained. The values of the individual mass transfer coefficients were estimated by means of straight line slopes. For this purpose, the reactive extraction yields were calculated for several extraction time values, at three extracting agent concentrations and four mixing intensity values. The obtained values are given in Table 1.

Taking in account the tabulated data, the values of the Penicillin G individual mass transfer coefficients for the aqueous phase were estimated by means of straight line slopes plotted in Figures 3, 4 and 5.

The values of these coefficients are given in Table 2.

As it was to be expected, the Penicillin G individual mass transfer coefficient increases rapidly with the increase of the considered parameters values. With an increase of 2.6 times of Amberlite LA-2 concentration in butyl acetate combined with an increase of 6.6 times of mixing intensity the mass transfer coefficient value are seen to increase about 15 times.

The following relationship was proposed between the individual mass transfer coefficient and the two process variables :

$$k_p = a \cdot C_a^b \cdot i^c$$

Table 1. The reactive extraction yield values in function of extraction time, at several extracting agent concentrations and several mixing intensity values..

$C_A,$ $g L^{-1}$	$i,$ $m s^{-1}$	extraction time, s						
		5	10	15	30	45	60	90
64	0.025	13.9	13.9	14.0	14.3	15.0	16.3	18.1
	0.050	16.8	18.1	19.2	19.5	20.0	21.0	24.2
	0.100	32.4	33.6	34.5	35.3	37.3	39.3	40.8
	0.165	75.0	76.3	77.0	78.8	79.8	82.5	90.0
92	0.025	14.4	15.2	15.8	16.8	17.3	18.5	19.1
	0.050	19.0	20.5	21.2	22.3	23.0	24.5	26.0
	0.100	37.1	39.8	40.2	41.3	42.5	46.1	47.8
	0.165	78.5	82.7	84.3	86.0	88.2	90.0	91.3
166	0.025	16.4	18.3	18.9	19.1	19.5	20.4	21.1
	0.050	21.3	22.8	23.2	24.1	25.0	26.8	27.2
	0.100	42.9	43.2	43.7	44.3	45.3	51.7	53.0
	0.165	87.1	89.0	89.4	90.1	91.9	93.5	94.9

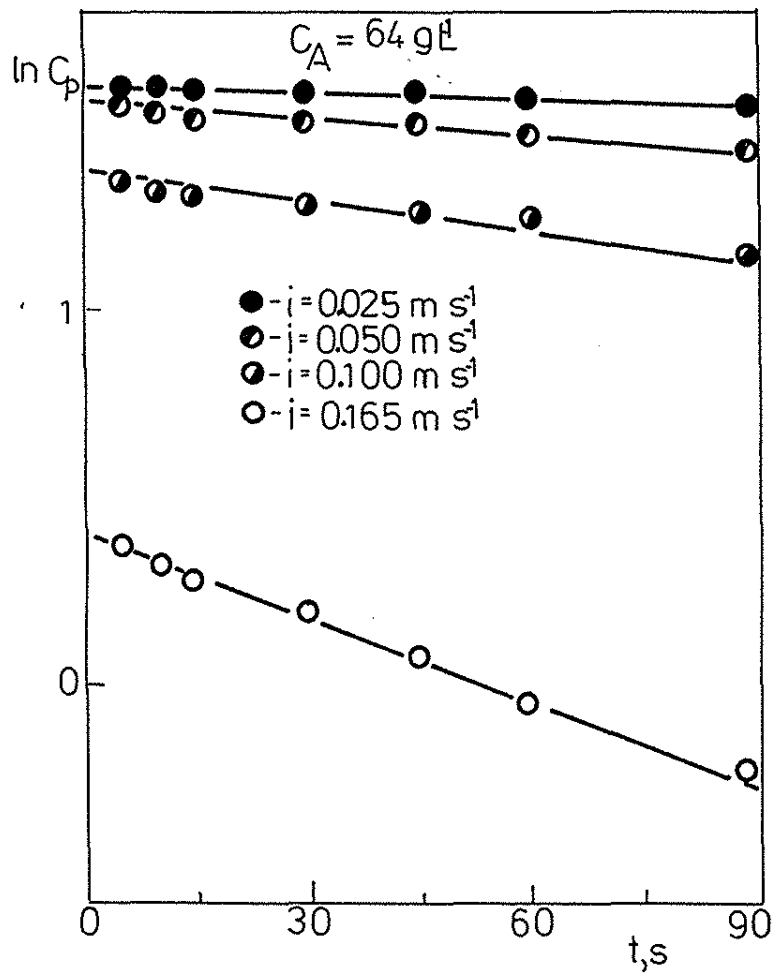

Figure 3. $\ln C_p$ versus mixing time for $C_A = 64 \text{ g L}^{-1}$.

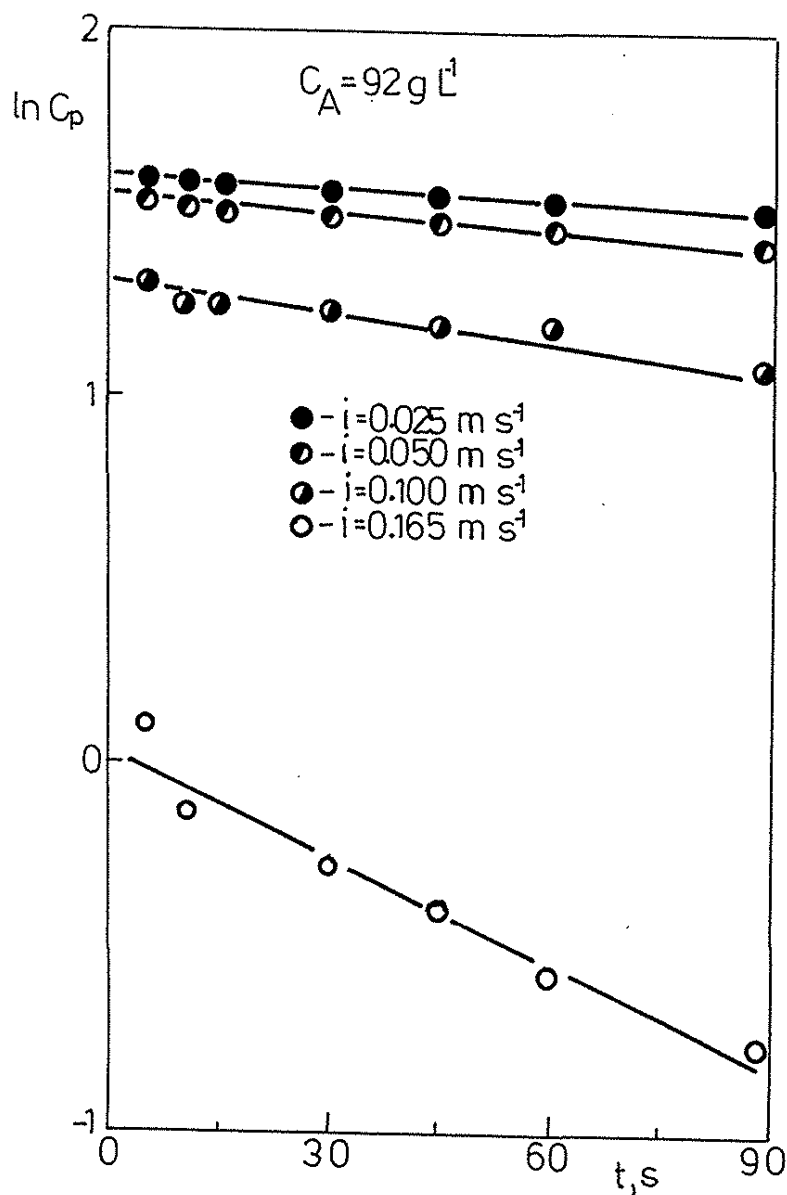

Figure 4. $\ln C_p$ versus mixing time for $C_A = 92 \text{ g L}^{-1}$.

**Figure 5.** $\ln C_p$ versus mixing time for $C_A = 166 \text{ g L}^{-1}$.

Table 2. The Penicillin G individual mass transfer coefficient values for the aqueous phase.

$C_A,$ $g L^{-1}$	$k_p \times 10^3, s^{-1}$			
	$i = 0.025 m s^{-1}$	$i = 0.050 m s^{-1}$	$i = 0.100 m s^{-1}$	$i = 0.165 m s^{-1}$
64	1.00	1.75	3.90	7.00
92	1.15	2.60	6.40	11.25
166	1.30	3.10	7.70	14.80

The coefficient a and the exponents b and c were determined by linearizing,⁴ for constant values of the extractant concentration, using the following relation :

$$k_p = a \cdot i^c$$

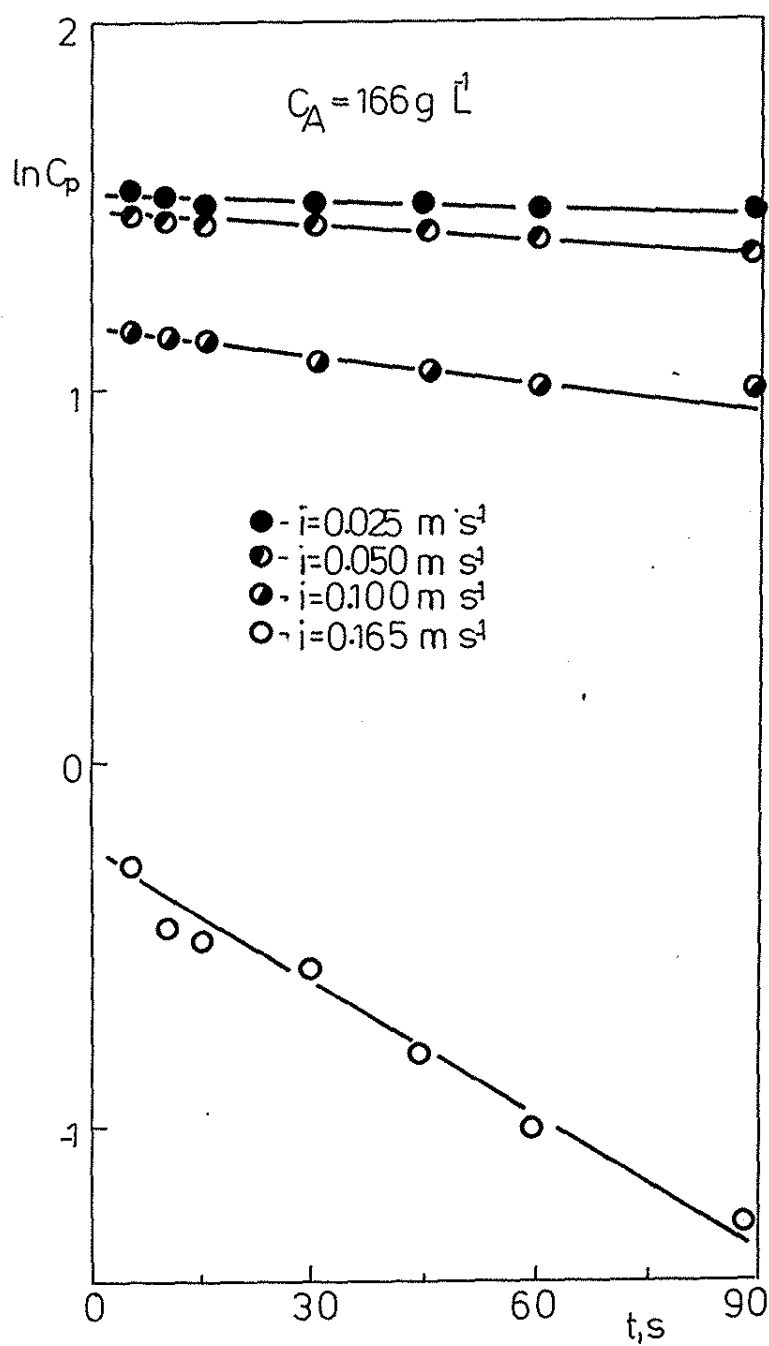
$$\text{or } \ln k_p = \ln a' + c \cdot \ln i$$

where $a' = a \cdot C_A^b$. By plotting $\ln k_p$ in function of $\ln i$ for the three concentration values of the extractant have been obtained the straight lines illustrated in Figure 6.

Thus, the following expressions can be written by means of these straight lines :

$$k_p = 0.046 \cdot i^{1.08} \quad \text{for } C_A = 64 g L^{-1}$$

$$k_p = 0.095 \cdot i^{1.20} \quad \text{for } C_A = 92 \text{ g L}^{-1}$$

$$k_p = 0.150 \cdot i^{1.30} \quad \text{for } C_A = 166 \text{ g L}^{-1} .$$

As can be observed, both the coefficient a' and the exponent c are influencing by the Amberlite LA-2 concentration. In order to settle this influence it was plotted a' and c values in function of extracting agent concentration obtaining two straight lines given in Figure 7.

These straight lines equations are :

$$a' = 0.91 \times 10^{-3} C_A$$

$$c = 1 + 1.77 \times 10^{-3} C_A$$

Now, the following correlation existing between the Penicillin G individual mass transfer coefficients for the aqueous phase and the Amberlite LA-2 concentration in butyl acetate and the mixing intensity can be written :

$$k_p = 0.91 \times 10^{-3} C_A i^{1 + 1.77 \times 10^{-3} C_A}$$

By using this relationship the theoretical values of Penicillin G individual mass transfer coefficients have been calculated. In Table 3 are presented the theoretical values and the ratio of theoretical and experimental values .

The proposed correlation offers a good concordance with the experimental values of mass transfer coefficients with an average deviation of 1.6 % and a maximum error of 18 %, as can be seen in Table 3.

Penicillin G Reactive Extraction

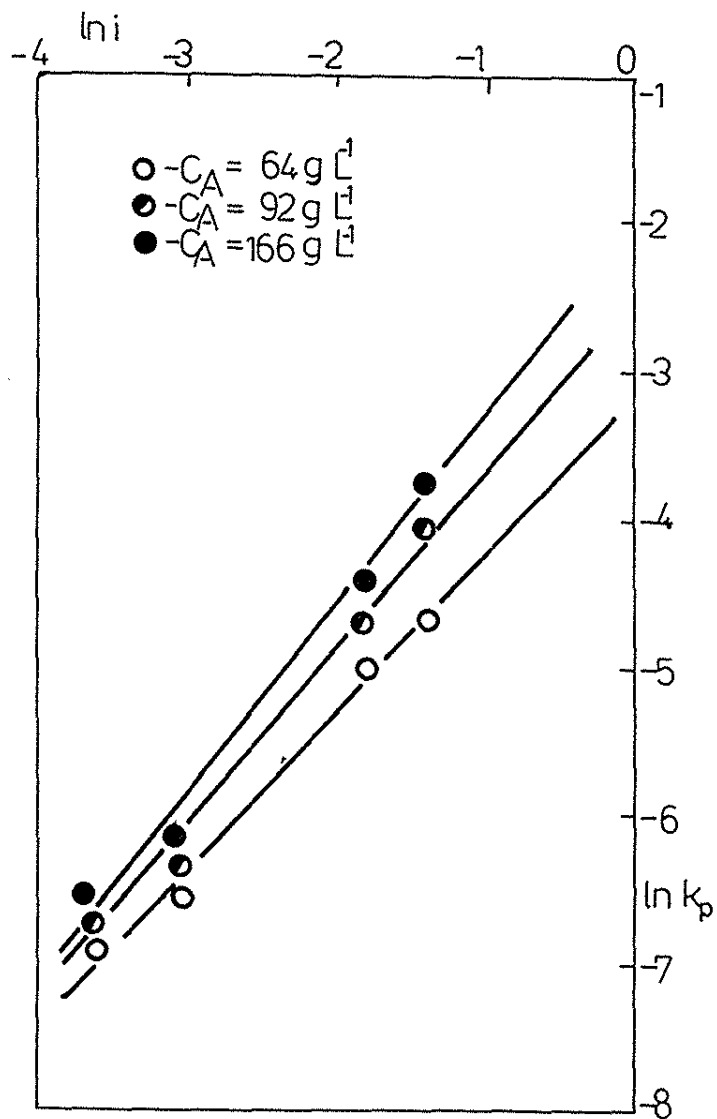

Figure 6. $\ln i$ versus $\ln k_p$.

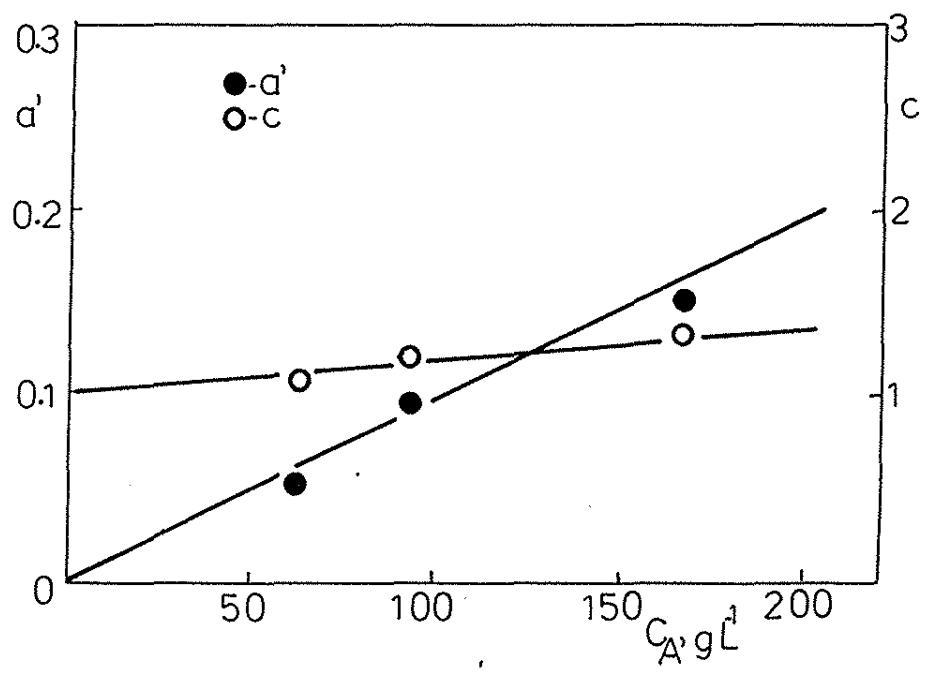

Figure 7. The influence of extracting agent concentration on coefficient a' and exponent c .

Table 3. The experimental and the theoretic values of the Penicillin G individual mass transfer coefficient for the aqueous phase.

$C_A, \text{g L}^{-1}$	$i, \text{m s}^{-1}$	$k_P \times 10^3, \text{s}^{-1}$	$k_{Pt} \times 10^3, \text{s}^{-1}$	k_{Pt} / k_P	r_{med}
64	0.025	1.00	0.96	0.96	1.016
	0.050	1.75	2.07	1.18	
	0.100	3.90	4.48	1.15	
	0.165	7.00	7.83	1.11	
92	0.025	1.15	1.15	1.00	
	0.050	2.60	2.57	0.99	
	0.100	6.40	5.75	0.90	
	0.165	11.25	10.30	0.92	
166	0.025	1.30	1.28	0.98	
	0.050	3.10	3.13	1.01	
	0.100	7.70	7.68	0.997	
	0.165	14.80	14.68	0.999	

CONCLUSIONS

For the mixing intensity values range bellow 0.165 m s^{-1} the Penicillin G diffusion is the reactive extraction process rate determining step. Over this value, the chemical reaction controls the separation process.

The proposed correlation between the Penicillin G individual mass transfer coefficients for the aqueous phase and the Amberlite LA-2 concentrations in organic phase and the mixing intensity values offers a quantitative description of the influence of these two parameters on reactive extraction process.

The aim of the future studies is to develop this correlation with the terms describing the pH - value, the volume ratio and the Penicillin G initial concentration influences.

List of Symbols

C_p - Penicillin G concentration, g L^{-1} ;

C_A - extracting agent concentration, g L^{-1} ;

k_p - Penicillin G experimental individual mass transfer coefficient for the aqueous phase, s^{-1} ;

k_{pt} - Penicillin G theoretical individual mass transfer coefficient for the aqueous phase, s^{-1} ;

i - mixing intensity, m s^{-1} ;

A - vibration amplitude, m;

f - vibration frequency, Hz;

r - ratio of theoretical and experimental mass transfer coefficients values;

t - extraction time;

Y - reactive extraction yield, %.

REFERENCES

1. C. Oniscu, "*Tehnologia produselor de biosinteza*", Editura Tehnica, Bucharest 1978 , pp. 190.
2. C. Oniscu, R. Tudose and D. Cascaval, *Rev. Roum. Chim.*, 39, 1343-1350 (1994).
3. C. Oniscu, D. Cascaval and V. Lungu, *Buletin I. P. I.*, 40, 71-76 (1994).
4. C. Balaban, "*Strategia experimentarii si analiza datelor experimentale*", Editura Academiei Romane, Bucharest 1993 , pp.94.

**KINETICS OF OXIDATION WITH HYDROGEN PEROXIDE AND
IRON(II) COMPLEX WITH A MACROCYCLIC BINUCLEATING
LIGAND**

Lourdes T. Kist¹, Bruno Szpoganicz^{**}, Manuel G. Basallote^{***}, Maria J. F. Trujillo^{***} and Maria A. Máñez^{***}

* Departamento de Química e Física, Universidade de Santa Cruz do Sul, Cx. P. 236, Santa Cruz do Sul/RS/ Brazil.

** Departamento de Química, Universidade Federal de Santa Catarina, Cx. P. 476, Florianópolis/SC/Brazil.

*** Departamento de Química Inorgánica, Facultad de Ciencias, Universidad de Cádiz, Apartado 40, Puerto Real/Spain.

ABSTRACT

In the present study solutions of a complex of Fe(II) with a macrocyclic ligand were prepared and their oxidation kinetics with hydrogen peroxide examined. The kinetic studies of the oxidation processes lead to values of rate constant of two step which occur via first-order kinetics. The results are expected to result in a better knowledge of the mechanism of H₂O₂ activation in catalyzed oxidation of organic substrates.

RESUMO

No presente estudo soluções de um complexo de um ligante macrocíclico com Fe(II) foram preparadas e sua cinética de oxidação com peróxido de hidrogênio é examinada. O estudo cinético do processo de oxidação mostra os valores das constantes de velocidade para duas etapas que ocorrem através de cinéticas de primeira ordem. Espera-se que os resultados sirvam para melhor compreensão do mecanismo de ativação do H₂O₂ na catálise de oxidação de substratos orgânicos.

KEYWORDS: iron(II), macrocyclic binucleating, oxidation kinetics

¹This article is part from a dissertation submitted by L.T.K. to the Faculty of Universidade Federal de Santa Catarina in partial fulfillment of the requirements for the degree of Doctor of Chemistry.

INTRODUCTION

The reduction of peroxides by transition metal complexes is important in many contexts because it is relevant for reactions that occur in biological systems and also for certain metal-catalyzed oxidations. The chemistry of non-heme iron centers has recently experienced a resurgence of interest as models for catalyzed oxidation. The incorporation of an oxygen atom into alkanes, alkenes, ethers and alicyclic, aromatic, and heterocyclic compound is very important and has practical applications in chemical industry as well as in sciences⁽¹⁾. One example of this applicability is the methane monooxygenase (MMO) that is found in methanotrophic bacteria which has one diiron active site and catalyzes the initial oxidation step in the conversion of methane to CO₂, in which one atom of dioxygen is incorporated into the C–H bond of methane to yield methanol^(2,3,4). Another structurally similar site is the dinuclear iron-oxo centers of hemerythrin^(5,6).

EXPERIMENTAL

The [Fe(CH₃CN)₆](BF₄)₂ and (MX₂DIEN₂) [3,6,9,17,20,23hexaazatriciclo (23.3.1)triaconta1(29),2,9,11(30),12,14,16,23,25,27-decaeno] (1) were prepared according to the literature procedures^(7,8). All manipulations were carried out under N₂ atmosphere using the standard Schlenck techniques. Reagents and solvents were obtained from Aldrich. Acetonitrile was distilled from P₄O₁₀ and it was also deoxygenated immediately before use. All the experiments were carried out at 25°C and ionic strength 0,05 molar in Bu₄NBF₄.

Stock solutions of [Fe(CH₃CN)₆](BF₄)₂ and the ligand were prepared under N₂ and transferred with teflon tube to the syringes of the stopped flow or to a flow cell placed in the spectrophotometer. The kinetics of reactions were studied under pseudo first-order conditions using an excess of the oxidant.

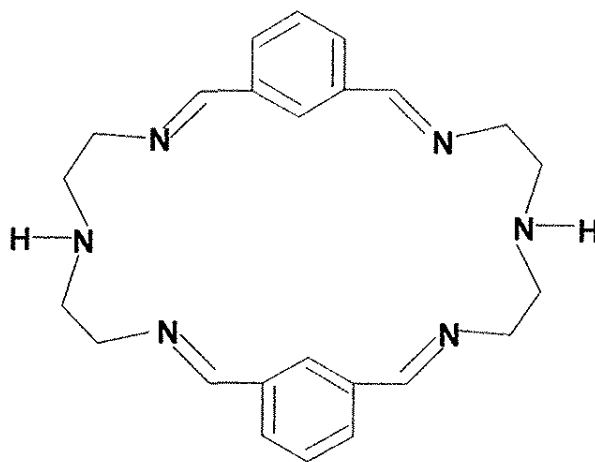

1 - Hexaaza macrocyclic binucleating ligand

L.T. Kist, B. Szpoganicz, M.G. Basallote, M.J.F. Trujillo & M.A. Mãñez

The kinetic information have been obtained in two different apparatus. For the slow reactions a Perkin-Elmer Lambda 3 spectrophotometer interfaced to PC-compatible computers was used and the rapid reactions were followed with an Applied-Photophysics stopped-flow DX17MV instrument interfaced to an Acorn 5000 computer. Absorbance versus time data were recorded and the data were analysed using the standard software of the instrument to obtain the pseudo-first order rate constants.

RESULTS AND DISCUSSION

Equilibrium mixtures of $\text{Fe}(\text{an})_6^{+2}$ (an= acetonitrile) and $\text{L}(\text{MX}_2\text{DIEN}_2)$ in 2:1 molar ratio in acetonitrile are stable under a N_2 atmosphere and show a band at 352 nm in the UV-Vis spectrum. These solutions contain the binuclear complex Fe_2L^{+4} in which two Fe(II) centers are coordinated to both N_3 subunits of the macrocycle and the remaining coordination site would be occupied by solvent molecules. When these solutions are mixed with solutions of water in acetonitrile, the spectral changes observed are very small and occur very rapidly (within the mixing time of the stopped-flow, about 2 ms). These small changes make impossible to determine the equilibrium constant for reaction of Fe_2L^{+4} with water and suggest that it is a fast process that leads to small amounts of substituted product. However, it seems unlikely that coordinated acetonitrile is not substantially substituted for water in the presence of a large water excess and so, an alternative explanation in that substitution of acetonitrile for water causes only minor changes in the spectrum of the complex.

Reaction of Fe_2L^{+4} with H_2O_2 in acetonitrile shows two kinetically distinguishable steps. The first step occurs in the stopped-flow time scale and it is characterized by an increase of absorbance at 480 nm (Figure 1). These kinetic traces in the presence of H_2O_2 excess can be easily analyzed by fitting to a single exponential to give the first order rate constant $k_{1\text{obs}}$ included in Table 1. Figure 2 shows the dependence of $k_{1\text{obs}}$ on the concentration of H_2O_2 and reveals a clear saturation behaviour. Actually, the reciprocal plot of Figure 3 illustrates the linear dependence of $1/k_{1\text{obs}}$ on $1/[\text{H}_2\text{O}_2]$. A linear least-squares fitting of points in Figure 3 leads to Equation [1], which is easily converted to Equation [2], in which the saturation behavior is more evident. Because H_2O_2 solutions for kinetic work were prepared from 30% aqueous H_2O_2 , this is the possibility that $k_{1\text{obs}}$ corresponds to reaction of Fe_2L^{+4} with H_2O instead of H_2O_2 . However this possibility can be ruled out because reaction with H_2O does not cause significant absorbance changes. Table 1 also includes kinetic data for the reaction with H_2O_2 . Moreover, the reproducibility of kinetic results in the presence of variable amounts of water indicates that free radicals (Fenton behaviour) are not involved in this reaction. On the contrary, kinetic experiments with *t*-BuOOH as oxidant showed small absorbance changes with unreproducible rate constant, which suggests that oxidation of Fe_2L^{+4} occurs in this case with formation of free radicals, i.e., the mechanism of the oxidation reaction is very dependent on the nature of the oxidant.

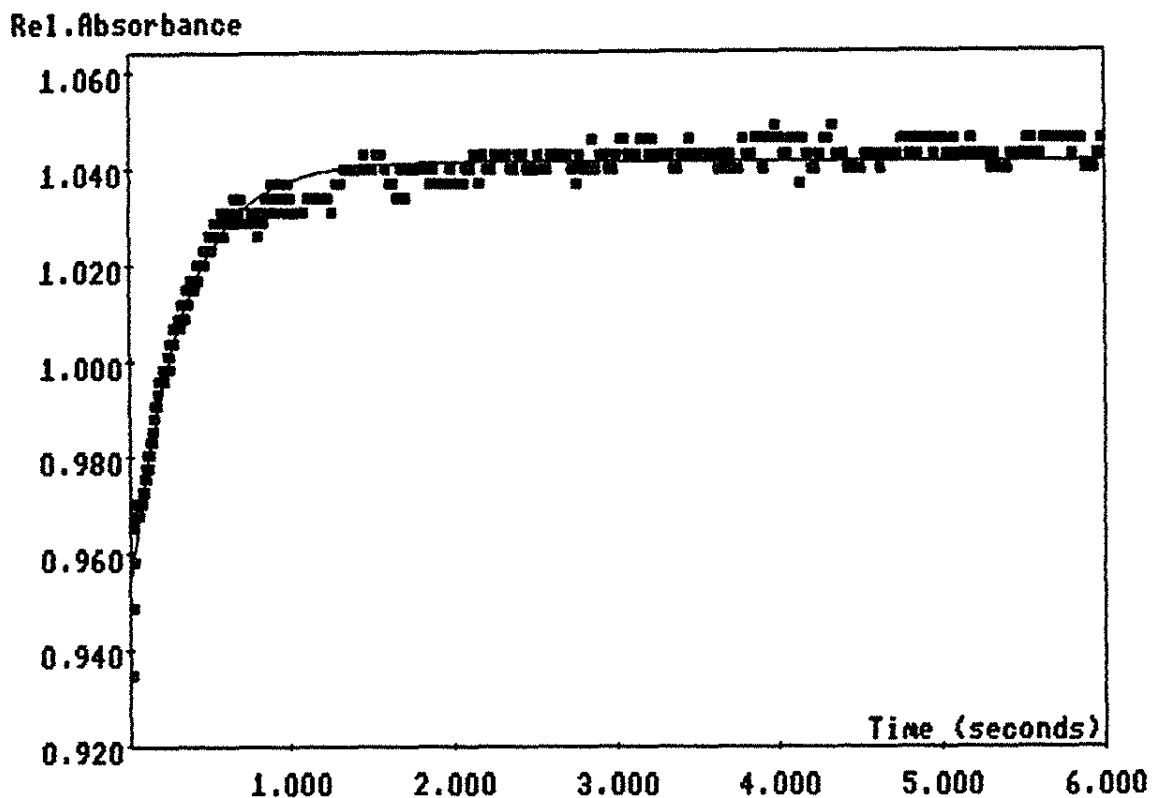

Figure 1: Absorbance versus time for the reaction of $[H_2O_2]$ 0,0960M and $\{Fe_2[(MX)_2(Dien)_2]\}^{+4}$ $5,0 \times 10^{-4}M$ in acetonitrile. Time: 1,0-5,0 s. $\lambda = 480$ nm. $T = 25^\circ C$. $\mu = 0,05M$. Nitrogen atmosphere.

Table 1 . Kinetic data at $25^\circ C$ for the fast step in the reaction of Fe_2L^{+4} with H_2O_2 (concentration of complex = $2,5 \times 10^{-3}M$)

$[H_2O_2]$ (M)	k_{1obs} (s^{-1})	$1/[H_2O_2]$ (M^{-1})	$1/k_{1obs}$ (s^{-1})
0.024	0.64	41.67	1.56
0.048	1.38	20.83	0.72
0.096	3.22	10.42	0.31
0.190	3.88	5.26	0.26
0.286	5.35	3.50	0.19
0.388	5.55	2.58	0.18
0.485	5.29	2.06	0.19
0.582	6.48	1.72	0.15
0.190 ^a	3.59		
0.190 ^b	3.78		
0.190 ^c	3.47		

^a 0.55 M additional water ^b 1.10 M additional water ^c 1.65 M additional water

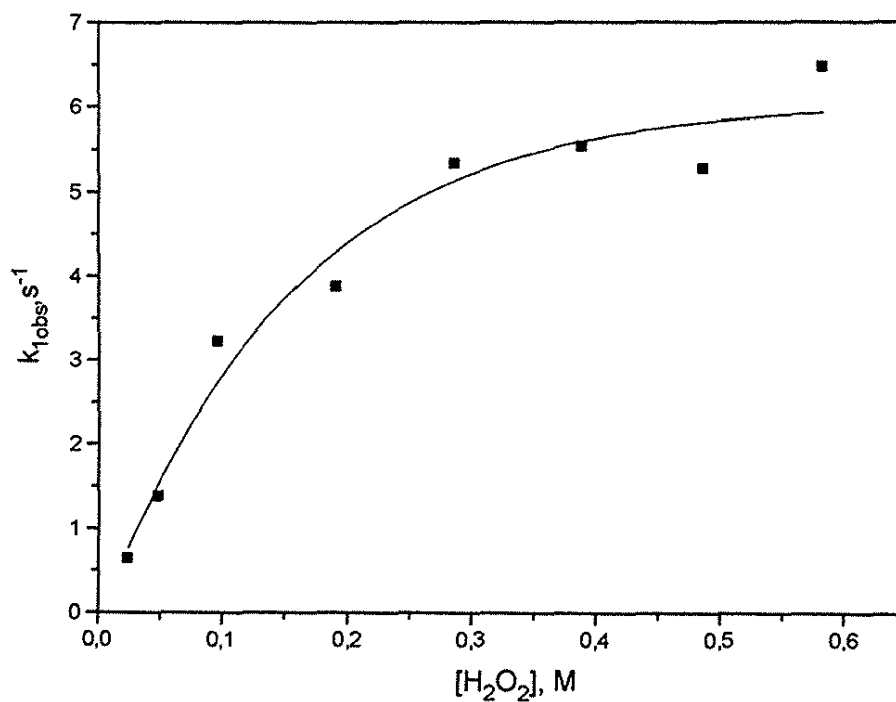

Figure 2: Plot of $k_{1\text{obs}}$ versus $[\text{H}_2\text{O}_2]$ for the fast step in the reaction with H_2O_2

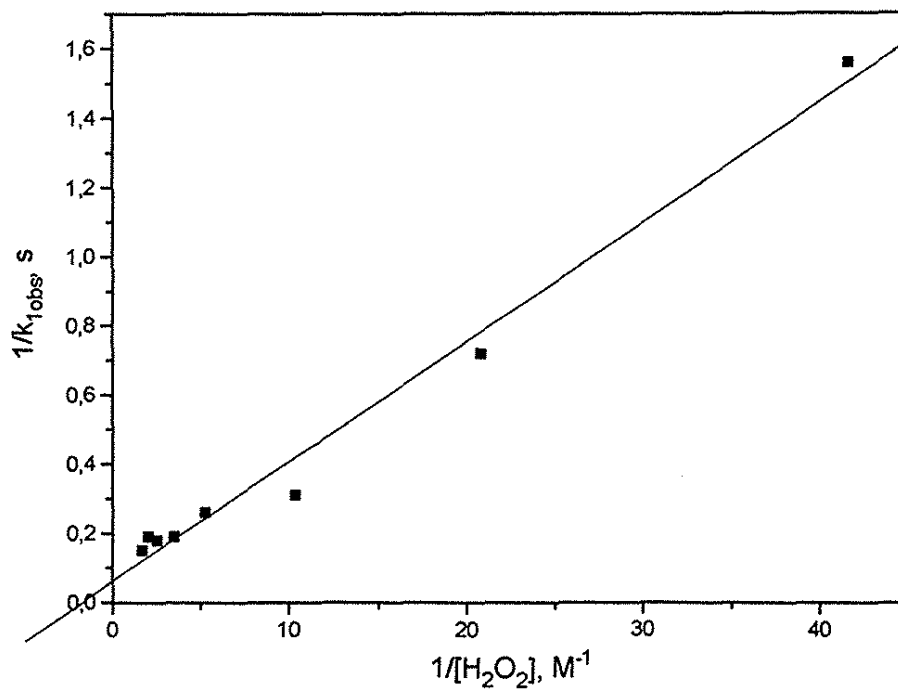

Figure 3: Reciprocal plot of kinetic data for the fast step in the reaction with H_2O_2

$$1/k_{1\text{obs}} = 0.064 + 0.035 1/[\text{H}_2\text{O}_2] \quad [1]$$

$$k_{1\text{obs}} = 28.6 [\text{H}_2\text{O}_2] / 1 + 1.8[\text{H}_2\text{O}_2] \quad [2]$$

Kinetic results for the H_2O_2 reaction can be interpreted with the mechanism proposed in Equations [3] and [4], where Equation[3] represents a fast equilibrium to form an intermediate B which converts more slowly to C.



$$k_{1\text{obs}} = k_2 K_1 [\text{H}_2\text{O}_2] / 1 + K_1 [\text{H}_2\text{O}_2] \quad [5]$$

The rate law for this mechanism is given by [5] and the comparison with [2] leads to $K_1=1,8 \text{ M}^{-1}$ and $k_2=15,9 \text{ s}^{-1}$. According to this interpretation, reaction of Fe_2L^{+4} with H_2O_2 would lead initially to the formation of a substituted product with $K_1=1,8 \text{ M}^{-1}$ and then B would be converted to an oxidized complex C with $k_2=15,9 \text{ s}^{-1}$.

In a slower reaction, complex C decomposes to give a mixture of reaction products difficult to characterize. The kinetics of this reaction was studied by conventional spectrophotometry and the values of the observed rate constant $k_{2\text{obs}}$ are given in Table 2. Figure 4 shows the linear dependence of $k_{2\text{obs}}$ on the concentration of H_2O_2 and linear least-squares fit of the data leads to equation [6].

$$k_{2\text{obs}} = 0.95 \times 10^{-4} + 3.11 \times 10^{-4} [\text{H}_2\text{O}_2] \quad [6]$$

This dependence and the formation of mixtures of products suggest that complex C decomposes through two parallel pathways with a different dependence on the concentration of oxidant. Moreover, the quality of the absorbance-time profiles and the dependence of $k_{2\text{obs}}$ with $[\text{H}_2\text{O}_2]$ are not very well defined because of precipitation and probably also because of some contribution of free radical pathways.

Table 2 : Kinetic data for the slow step in the reaction of Fe_2L^{+4} with H_2O_2 (same conditions that data of Table 1)

$[\text{H}_2\text{O}_2]$ (M)	$10^4 k_{2\text{obs}}$ (s^{-1})
0,048	1.21
0,096	1.02
0,190	1.70
0,380	2.10

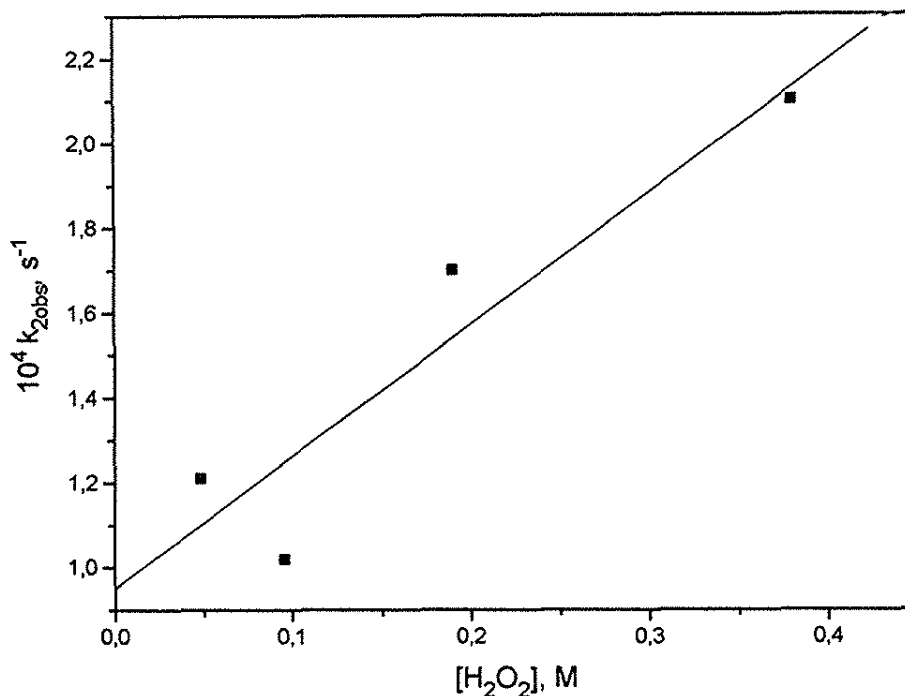
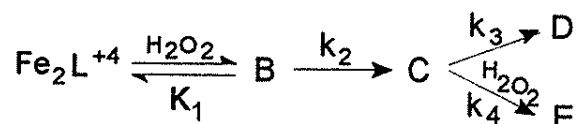

Figure 4: Dependence of k_{2obs} on the concentration of H_2O_2 for the slow step in the reaction with H_2O_2

Thus, kinetic results for the reaction of Fe_2L^{+4} with H_2O_2 in acetonitrile solution can be summarized with the following scheme:



The values derived for the constant are: $K_1=1,8 M^{-1}$, $k_2=15,9 s^{-1}$, $k_3=0,95 \times 10^{-4} s^{-1}$ and $3,11 \times 10^{-4} M^{-1} s^{-1}$. These data represent a full description of the reaction system as a function of time and can be used as a first approximation to the study of H_2O_2 oxidations catalyzed by the binuclear complex Fe_2L^{+4} . According to kinetic results, oxidation of organic substrate is most likely to occur through reaction with species C, because complex B is a substituted product and complexes D and E are decomposition products unable to react with more H_2O_2 . Further work is in progress to the determine the nature of intermediate C and its role as active oxidant for different organic substrates.

ACKNOWLEDGEMENT. We thank Junta de Andalucía (Spain) and CAPES/PICD (Brazil) for financial support.

REFERENCES

- 1- D.H.R. Barton, A. E. Martell and D.E. Sawyer, "*The Activation of Dioxygen and Homogeneous Catalytic Oxidation*", Plenum Publishing Comp., New York (1993), pp. 1-497.
- 2- A. Stassinopoulos, G. Schulte, G.C. Papaefthymiou and J.P. Caradonna, *J. Am. Chem. Soc.* 113:8686-8697(1991).
- 3- K.E. Liu, C.C Johnson, M. Newcomb and S.J. Lippard, *J. Am. Chem. Soc.* 115;3:938-947(1993).
- 4- A.L. Feig and S.J. Lippard, *Chem. Rev.* 94;759-805(1994).
- 5- Wilkins, R.G., *Chem. Soc. Rev.* 171-178(1992).
- 6- D.M. Kutz Jr., *Chem. Rev.* 90:759-805(1990).
- 7- B.J. Hathaway, D.G. Holah and A.E. Underhill, *J. Chem. Soc.* 468:2444-2447(1962).
- 8- R. Menif, A.E. Martell, P.J. Squattrito and A. Clearfield, *Inorg. Chem.* 29:4724-4729(1990).

**SYNTHESES OF SOME PHENOXATHIIN DERIVATIVES
WITH ANTIMICROBIAL ACTIVITY**

O.MAIOR*, D.GAVRILIU* and S.STOIA**

* Faculty of Chemistry, Organic Chemistry Dept., University of Bucharest,
90-92 Panduri Road, Romania.

** Faculty of Food Products Technology, Biochemistry Dept., University of Sibiu,
3-5 Ion Rațiu Street, Romania.

ABSTRACT

Antimicrobial activity has been studied on eighteen substances of phenoxathiin class (six of them being not yet described in literature) evincing the fact that the oxidizing of the sulfur atom in position 10 leads to a severe decrease of the antibacterian activity.

RESUMO

Foi estudada a atividade antimicrobiana de dezoito compostos da classe da fenoxatiina, seis dos quais não foram descritos na literatura. Os resultados experimentais mostram que a oxidação do enxofre na posição 10 leva a uma grande diminuição da atividade antibacteriana.

Keywords: phenoxathiin, antimicrobial activity, sulfonium salts, O-methyl oximes.

INTRODUCTION

Following some research which revealed the antimicrobial activity of certain phenoxathiin derivatives [1-4], the present paper contains the results of the synthesis of new compounds from this class, for evincing the role played by the substituent upon the activity.

Six new compounds were synthesized starting from acetylphenoxathiin, together with other twelve already known products, which were obtained according to the literature, in order to complete the series of derivatives which were subject to the antimicrobial tests. (Scheme 1).

SCHEME 1

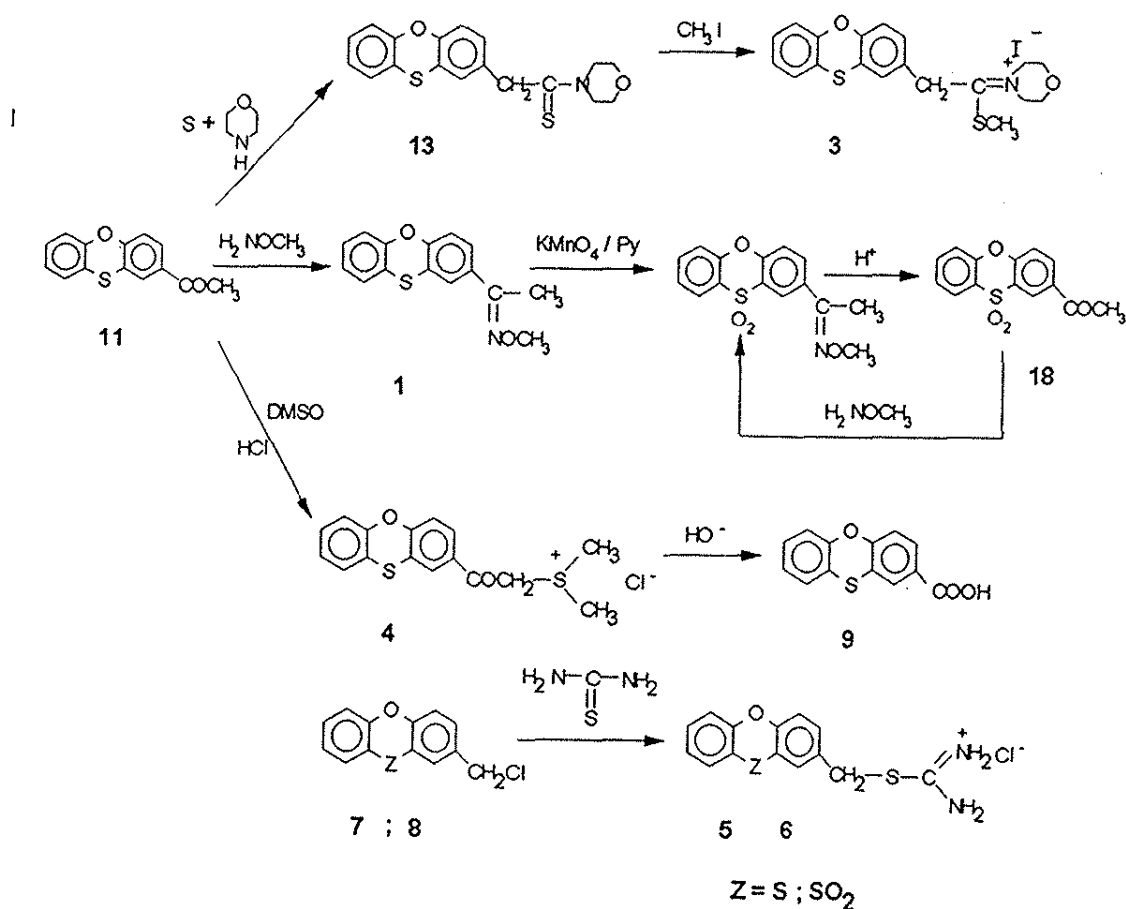

EXPERIMENTAL

Melting points were determined in open capillary for compounds 1-5, with Boetius apparatus for compound 6, and are uncorrected.

IR spectra were recorded in KBr pellet with an UR-20 apparatus.

¹H-NMR spectra were recorded on a BRUCKER apparatus in DMSO-*d*₆.

Thin-layer chromatography (TLC) was realised on silica gel Merck plates, unidimensional technic, the development was done by using different solvent systems (Table 1). Visualisation was done with iodine for phenoxathiin-10, 10-dioxides or with conc. sulfuric acid for phenoxathiins (coloured spots of phenoxathiin cation radical).

Aminooxymethyl-(2-phenoxathiinyl)-ethanone (1):

To 1.5 g (6.1 mmole) 2-acetylphenoxathiin and 1 g (11 mmole) O-methylhydroxylamine hydrochloride, a mixture of 4 ml (49 mmole; $d=0.978$) pyridine and 4 ml methanol was added.

The reaction mixture was warmed for 45 minutes on steam-bath. After cooling, an oil was formed, which crystallized by adding 20 ml water. The precipitate was filtered off, washed with 2 ml methanol and air dried. 1.55 g (92.8% yield) of **1** were obtained; m.p. = 79-80° (methanol).

Aminooxymethyl-(2-phenoxathiinyl-10,10-dioxide)-ethanone (2):

A. To 1.7 g (6.2 mmole) 2-acetylphenoxathiin-10,10-dioxide and 1 g (11 mmole) O-methylhydroxylamine hydrochloride, a mixture of 7 ml (86 mmole; $d=0.978$) pyridine and 5 ml methanol, was added. The reaction mixture was warmed for 4 h on steam-bath and then 20 ml water were added. The white precipitate which formed was filtered off, washed with 2 ml methanol and air dried. 1.7 g (90.8% yield) of **2** were obtained; m.p. = 153-154° (isopropanol).

B. To 0.6 g (2.2 mmole) of **1** dissolved in 2 ml (24 mmole; $d=0.978$) pyridine, 0.87 g (5 mmole) potassium permanganate in 3 ml water were added. The reaction mixture was warmed for 1.5 h on steam-bath, and then 20 ml water were added.

Mangan dioxide was filtered off and extracted with 20 ml methylene chloride. The filtrate was also extracted with 5 ml methylene chloride. The organic phases were reunited and concentrated. 0.35 g (52.2% yield) crude of **2** with m.p. = 147-149° were obtained.

After recrystallization from isopropanol, the product has m.p. = 153-154°.

S-methyl-(2-phenoxathiinyl)-acetomorpholidium iodide (3):

0.7 g (2 mmole) thiomorpholide of 2-phenoxathiinacetic acid were treated at room temperature with 7 ml (112 mmole; $d=2.28$) iodometane. A clear solution, which was left overnight, was obtained. The yellow precipitate formed, was filtered off and washed with 1 ml methylene chloride. 0.8 g (80.8% yield) of **3** were obtained; m.p. = 156-157°.

¹H-NMR: 4.53 (s, -CH₂-), 2.77 (s, -CH₃), 4.09-4.18 (two triplets of two -CH₂-groups bonded to morpholine's nitrogen), 3.77-3.92 (two triplets of the two -CH₂-groups bonded to morpholine's oxygen) and 7.04-7.29 (multiplet aromatic) ppm.

1-[(2-Phenoxathiinylcarbonyl) methyl] dimethylsulfonium chloride (4):

To 1.21 g (5 mmole) 2 acetylphenoxathiin and 20 ml dimethyl sulfoxide, gaseous hydrochloric acid is bubbled inside this mixture at temperature under 10 °C.

After saturation with hydrochloric acid, the reaction mixture was left overnight at room temperature, the acid in excess was removed at low pressure. The reaction mixture was treated with 45 ml diethyl ether. The layer of dimethyl sulfoxide was separated, the precipitation of **4** was intensified by adding 25 ml methanol.

The precipitate was filtered off and 1 g (59.1% yield) of **4** with m.p. = 159-160°, was obtained.

¹H-NMR : 2.96 (s, -CH₃), 5.44 (s, -CH₂-), 7.11-7.93 (multiplet aromatic) ppm.

S-(2-phenoxathiinomethyl)-isothiuronium chloride (5):

To 0.2g (2 mmole) thiourea dissolved in 6 ml anhydrous acetone, 0.6 g (2 mmole) 2-chloromethylphenoxathiin [8] were added and heated on steam-bath for 10 minutes.

The precipitate formed on cooling, was filtered off and washed with 1 ml acetone. 0.6 g (76.4% yield) with m.p.=230-231.5° (dec.; anhydrous ethanol) were obtained.

S-(2-phenoxathiinomethyl-10,10-dioxide) isothiuronium chloride (6):

The synthesis of 6 was done in the same way, the isothiuronium salt of 2-chloromethyl phenoxathiin-10,10-dioxide was obtained with m.p.=254-256° and 71.4% yield.

2-Phenoxathiincarboxylic acid (9):

0.3 g (0.88 mmole) of 4 and 7 ml sodium hydroxide 8% were heated under reflux for 2 h. The solution obtained was treated with activated carbon and filtered off. The filtrate was extracted with 10 ml ethyl acetate. The aqueous phase, in which the sodium salt of 9 partially precipitated, was acidified with conc. hydrochloric acid up to pH=3.

2-Phenoxathiincarboxyl acid which precipitated, was filtered off. 0.5 g (71.4% yield) of 9 with m.p.=247° were obtained, according to literature data.

2-Acetylphenoxathiin-10,10-dioxide (18):

0.1 g (0.33 mmole) of 2 was heated on steam-bath, at 60-70°, with 5 ml hydrochloric acid 3 N for 2.5 h.

The reaction mixture was extracted with methylene chloride and the organic phase was concentrated.

0.085 g (yield 93.8%) of 2-acetylphenoxathiin-10,10-dioxide with m.p.=167-168° were obtained (according to literature data [7], m.p.=166-167°).

RESULTS AND DISCUSSION

In this paper an antimicrobial screening was done for a series of eighteen compounds from the phenoxathiin class. In this respect, the 4 and 5 phenoxathiin derivatives showed a strong antibacterial activity, while the 6-12 ; 14 derivatives had a low activity and the 1-3; 13; 15-18 compounds showed a rather insignificant biological activity (Table 1).

TABLE 1

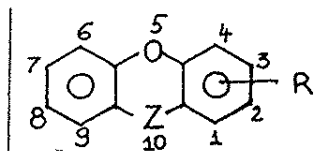

The compounds 1-18 microbiologically tested.

Nr.	R	the position of R	Z	Rf	% S		Ref.
					% S calc.	% S found	
1	$\begin{array}{c} \text{-C-CH}_3 \\ \parallel \\ \text{NOCH}_3 \end{array}$	2	S	0.87	11.81	11.73	--
2	$\begin{array}{c} \text{-C-CH}_3 \\ \parallel \\ \text{NOCH}_3 \end{array}$	2	SO ₂	0.65	10.57	10.35	--
3	$\begin{array}{c} \text{-CH}_2\text{-C=N} \\ \parallel \\ \text{S-CH}_3 \end{array}$	2	S	0.96	13.21	13.00	--
4	$\begin{array}{c} \text{-C-CH}_2\text{-S} \\ \parallel \\ \text{O} \end{array}$	2	S	0.51	18.92	18.92	--
5	$\begin{array}{c} \text{-CH}_2\text{-S-C=NH}_2 \\ \parallel \\ \text{NH}_2 \end{array}$ Cl ⁻	2	S	0.75	19.74	19.66	--
6	$\begin{array}{c} \text{-CH}_2\text{-S-C=NH}_2 \\ \parallel \\ \text{NH}_2 \end{array}$ Cl ⁻	2	SO ₂	0.64	17.92	17.96	--
7	-CH ₂ Cl	2	S	--	--	--	[8]
8	-CH ₂ Cl	2	SO ₂	--	--	--	[8]
9	-COOH	2	S	--	--	--	[8]
10	-COOH	2	SO ₂	--	--	--	[8]
11	-COCH ₃	2	S	--	--	--	[10]
12	-COCH ₃	3	S	--	--	--	[11]
13	$\begin{array}{c} \text{-CH}_2\text{-C-N} \\ \parallel \\ \text{S} \end{array}$	2	S	--	--	--	[7]
14	-CH ₂ COOH	2	S	--	--	--	[7]
15	-CH ₂ COOH	2	SO ₂	--	--	--	[7]
16	$\begin{array}{c} \text{-C-CH}_3 \\ \parallel \\ \text{NOH} \end{array}$	2	S	--	--	--	[13]
17	$\begin{array}{c} \text{-C-CH}_3 \\ \parallel \\ \text{NOH} \end{array}$	3	S	--	--	--	[12]
18	-COCH ₃	2	SO ₂	--	--	--	[7]

Eluent: a) petroleum ether:methylene chloride:diethyl ether:ethyl acetate-7.5:2:1:1.

b) n-butanol:acetic acid:water-4:1:1.

c) methylene chloride:ethyl acetate-9:1.

The microbiological tests of these compounds were realised on both standard strains, Gram-positive and Gram-negative germs clinically isolated from varied infections sources.

In bacteriological tests, N,N-dimethylformamide, was used as solvent, which did not have its own antimicrobial activity.

For the diffusion tests, a Mueller-Hinton medium pH=7.2 was used, supplemented with ram blood in case of Streptococci [5]. For preparation of inocula, the glucose-broth was used.

The antibacterial activity was determined by the inhibition zone method [6] on Mueller-Hinton plates, with the concentration of the tested substances of 200 µg/disk or respectively 100 µg/disk. The impregnated disks of 5 mm diameter were initially sterilised by autoclavation.

The disks impregnated with substances were applied on plates sown with bacteria. After an overnight incubation at 37 °C, the inhibition zones were read (in mm including the diameter of the disk), the measurement being made in two or three different directions. For comparison, on each plate were applied two classical antibiotics, ampicillin (10 µg/microtablet) and kanamicin (30 µg/microtablet). The experimental results were expressed by the inhibition zone diameter (mm) produced by each substance against the clinical isolates of bacteria. Also, the inhibition zone diameter for standard strains, tested under the same conditions as the clinical isolates, were measured.

So, from the microbiological data (Tables 2 and 3), compared to 2-chloromethylphenoxathiin, the corresponding 10,10-dioxide (compound 8) shows a lower antimicrobial activity on a much smaller number of bacteria strains. The corresponding isothiuronium salts were obtained starting from these two compounds. The isothiuronium salt of 2-chloromethylphenoxathiin had a large antibacterial spectra both on Gram-positive and Gram-negative strains, while its corresponding 10,10-dioxide had an antibacterial activity only on *Morganella morganii* strains.

Also, 2-acetyl- respectively 3-acetylphenoxathiin showed a significant antibacterial activity on *Morganella morganii* strains, while their oximes and aminoxy derivatives did not have any activity at all (Table 3).

Starting also from 2-acetylphenoxathiin, the corresponding thiomorpholide was obtained through the Willgerodt reaction [7], which treated with iodomethane in excess, lead to the compound 3. None of these two compounds have any antimicrobial activity, but the acid hydrolysis of thiomorpholide leads to 2-phenoxathiinacetic acid, which has as low an antimicrobial activity as his corresponding 10,10-dioxide.

A strong antibacterial activity is also shown by the sulfonium salt 4, which through alkaline hydrolysis leads to 2-phenoxathiincarboxylic acid with a much lower biological activity.

TABLE 2

Antimicrobial activity of the compounds 4-6 and 11-12.

Compound	4	5	6	11	12	A	K
Strain							
Staph.aureus 13204	15 ^a	12 ^a	-	-	-		
Staph.Oxford 10279	14 ^a	12 ^a	-	-	-		
Ps.aeruginosa 13202	-	-	-	-	-		
E.coli 13203	-	15 ^a	-	-	-		
Staph.aureus (othical secretion)	12 ^b	15 ^a	-	-	-	20	24
Staph.aureus (nasal secretion)	14 ^b					15	22
Staph.aureus (urethral secretion)	10 ^a					20	29
Strpt.haemolyticus (purulent secretion)	10 ^b						
Staph.aureus (purulent secretion)	12 ^a	12 ^a	-	-	-	-	-
Shigella S.	-	12 ^a	6 ^a	-	-	-	19
E.coli	-	12 ^a	-	-	-	-	22
Shigella Flexneri	-					-	26
Ps.aeruginosa (uroculture)	-	14 ^a	-	-	-	-	-
Pr.vulgaris	8 ^b	-	-	-	-	-	-
Salmonella enteritidis	-	10 ^a	-	-	-	19	26
Staph.aureus (hemoculture)	-	12 ^a	-	-	-	24	-
Bacillus subtilis	-	10 ^a	-	-	-		
Morganella morganii	-	20 ^a	14 ^a	10 ^a	10 ^a	-	24
Citrobacter	-	6 ^a	-	-	-	-	-

a = tested substance conc. 10 mg/ml (200 µg/disk).

b = tested substance conc. 5 mg/ml (100 µg/disk).

A = ampicillin (10 µg/microtablet).

K = kanamicin (30 µg/microtablet).

- = normal growth of bacteria.

TABLE 3

Antimicrobial activity of the compounds 7-10 and 14.

Compound	7	8	9	10	14
Strain					
Staph. 12793	7	6.5	-	-	7
Staph. 11020	9	7	-	-	7.4
Staph. 11345	7	-	6	7	6.2
Staph. 313	6	-	-	-	7
Staph. aureus 19	6	8	6	-	-
Staph. citr. 52	8	6	6	6	-
Staph. 12449	9	6	-	6	6.6

In literature is well known the fact that the phenoxathiin nucleus oxidizing in position 10 [1], generates a strong diminution of the biological activity, data which are confirmed also in the present paper. In this respect, the turning through oxidizing of compounds 5,7,9,11 and 14 into their analogues 10,10-dioxides leads to a strong decrease of the antibacterial activity.

The 2-phenoxathiincarboxylic acid, prepared in literature also through the King reaction, starting from 2-acetylphenoxathiin [8] was obtained by means of a new way, respectively through the alkaline hydrolysis of sulfonium salt obtained as a result of the reaction between dimethyl sulfoxide, hydrochloric acid and 2-acetylphenoxathiin.

The hydrolysis of this salt with methanolic sodium hydroxide, in the conditions described in literature for the acetophenone sulfonium salt [9], did not lead to satisfactory results.

The protection of 2-acetylphenoxathiin carbonyl group as aminoxy derivative, in the oxidizing reaction with potassium permanganate, allowed the obtaining of 10,10-dioxide without the oxidation of the side chain.

The removing of the protective group in acid conditions leads to 2-acetylphenoxathiin-10,10 dioxide.

IR spectra for the compounds 1-6 are presented in Table 4.

TABLE 4

Characteristic vibrations of the compounds 1-6.

Compound	γ 4CH (cm^{-1})	γ 2CH (cm^{-1})	ν C=O (cm^{-1})	ν C=N (cm^{-1})	ν C-O-C (cm^{-1})	SO ₂ (cm^{-1})	Other vibrations (cm^{-1})
1	745	832	-	1592	1230	-	-
2	760	840	-	1596	1232	562 1158 1232	-
3	750	820	-	1580	1275	-	1340- ν s-CH ₃ 1115- ν c-o-c morpholine ring
4	755	825	1675	-	1230	-	1350- ν s-CH ₃
5	750	825	-	1648	1245	-	3040- ν ^{sim} NH ₂ 3190- ν ^{d5} NH ₂
6	770	840	-	1640	1252	570 1170 1290	3080- ν ^{sim} NH ₂ 3235- ν ^{d5} NH ₂

CONCLUSIONS

Six new compounds of the phenoxathiin class were obtained and characterised. They were tested for their antimicrobial activity together with other twelve compounds from this class.

The compounds 4 and 5 have a significant antibacterial activity.

The oxidizing of the sulfur atom on position 10 of the phenoxathiin nucleus leads to a strong decrease or loss of the antimicrobial activity.

The protection of carbonyl group in 2-acetylphenoxathiin was done by turning it into aminoxy derivate which allowed the sulfur atom in position 10 to be oxidized without affecting the side chains.

REFERENCES

1. O. Maior, "Contribuții la chimia fenoxatiinei"-thesis, Buc. 1965.
2. M. Tomita and W. Watanabe, *J. Pharm. Soc. Japan*, **71**, 1204 (1951);
Chem. Abstr., **46**, 7618 (1952).
3. O. Maior, *Rev. Chim. (Buc.)*, **20**, 593 (1969).
4. D. Gavrilu, S. Stoia and O. Maior, *Rev. Chim. (Buc.)*-in press.
5. M. Balș, "Terapia infecției", ed. II, Ed. Med. Buc., 297-305 1971.
6. V. Bîlbîie and N. Pozsgî, "Bacteriologia Medicală", vol II, Ed. Med. Buc.,
343-358 1984.
7. O. Maior, *Anal. Univ. Buc.*, **XIV**, 105 (1965).
8. G. Vasiliu and O. Maior, *Anal. Univ. Buc.*, **XIII**, 103 (1964).
9. E. Goethals and P. Radzitzky, *Bull. Soc. Chem. Belges.*, **73**, 579 (1964).
10. O. Maior and M. Stanciu, *Rev. Chim. (Buc.)*, **20**, 529 (1969).
11. O. Maior, D. Stoicescu, L. Stancovski and D. Gavrilu,
11 Symposium of Heterocyclic Compounds, P 89, Prague, 29 Aug.-4 Sept.
1993.
12. O. Maior and G. Loloiu-manuscript in preparation.
13. E. Lescot, Ng Ph. Buu-Hoi and N. D. Xuong, *J. Chem. Soc.*, 2408 (1956).

CARBON-13 NMR OF ALIPHATIC TERTIARY AMINES

Paulo Irajara Borba Carneiro*
Instituto de Química, Universidade Federal do Paraná
Caixa Postal 19081
81.531.970 Curitiba-PR - Brasil

Roberto Rittner
Instituto de Química, Universidade Estadual de Campinas
Caixa Postal 6154
13081 Campinas-SP - Brasil

ABSTRACT

There are few data for the tertiary aliphatic amines in the literature. Unpublished Carbon-13 NMR data for seven aliphatic tertiary amines are reported and are inédited. The empirical substituent effects of the NMe_2 and NEt_2 groups were determined and can be useful in correlation analysis.

RESUMO

O presente trabalho apresenta dados inéditos de deslocamentos químicos para sete aminas alifáticas terciárias. Os efeitos empíricos do substituinte para os grupos NMe_2 e NEt_2 foram determinados e podem ser úteis em análise correlacional.

KEY WORDS: Carbon-13 NMR, chemical shifts, aliphatic tertiary amines.

INTRODUCTION

Recently, we have studied aliphatic compounds by Carbon-13 NMR spectroscopy¹. Although aliphatic tertiary amines are important starting material for some synthetic routes, there is a lack of NMR data in the literature². We have synthesized several aliphatic tertiary amines of the type R-X where R is a alkyl group containing two to six carbon atoms (Ethyl, propyl, butyl, amyl and hexyl groups), and X represents the NMe_2 or NEt_2 groups. The purpose of this work was to synthesized seven aliphatic tertiary non branched amines with sp^3 hybridization, to record their Carbon-13 NMR data for their full characterization, and to determine the empirical effects of the NMe_2 and NEt_2 groups. The chemical shifts for these compounds have not been reported in the literature and the empirical effects can be useful in correlation analysis.

* Author to whom correspondence should be addressed

EXPERIMENTAL PROCEDURE

Materials: All compounds were prepared by described in the literature procedures⁴. The physical and spectral data are shown in Tables 1-3. Solventes were of spectroscopic quality and were used without further purification.

Spectra: the C-13 NMR spectra of 1,0 M solutions in CCl₄ with 5 % TMS as an internal reference in 10 mm o.d. sample tubes, were recorded at 25,2 MHz using a Varian XL-100 spectrometer in the FT mode. The conditions were as follows: pulse width, 20 μ s; acquisition time, 0,67 s; spectral width, 6150 Hz; pulse repetition time, 0,4 s; temperature, 30 °C; internal lock, D₂O; angle tumbling, 45°; number of transients, 6000; and number of data point, 8192. The C-13 NMR spectra were recorded in both the proton-noise decoupled and coupled modes. The H-1 NMR spectra of the several investigated solutions, in 5 mm o.d. sample tubes, were recorded at 80 MHz using a Bruker AW-80 spectrometer in the FT mode.

RESULTS AND DISCUSSION

Table 1 shows the physical constants of these compounds. They agree whit published data. The H-1 NMR data are shown in Table 2 and Table 3 shows the C-13 NMR data. Table 4 shows the empirical effect theses dialkylamine groups. The synthesis of seven tertiary amines allow to amplify the C-13 NMR data these amines and to estimate in the straight form the empirical effect of these groups. The four empirical effects α , β , γ and δ are defined as follows. The signals of aliphatic carbons were assigned by single-frequency off-resonance decoupling (SFORD) and proton noise decoupled (DFL) spectra, and known chemical shifts rules². We have determined the empirical effects of the NMe₂ and NEt₂ groups, wich were not been previously reported in the literature. These values can be useful in correlation analysis.

Table 1. Physical Constantes of Aliphatic Tertiary Amines³

Compounds	b.p (°C/Torr)	Yield (%)
1 N,N-Dimethyl-N-ethylamine	36/760	70
2 N,N-Dimethyl-N-propylamine	60/760	80
3 N,N-Dimethyl-N-butylamine	95/760	60
4 N,N-Dimethyl-N-pentylamine	120/760	60
5 N,N-Diethyl-N-propylamine	105/760	84
6 N,N-Diethyl-N-pentylamine	50/20	60
7 N,N-Diethyl-N-hexylamine	80/25	80

Table 2. H-1 NMR Chemical Shifts of Aliphatic Tertiary Amines in ppm Relative to TMS³ (Solvent CCl₄)

Compounds	H-1	H-2	H-3	H-4	H-5	H-6	H-1'	H-2'
1	2.25	0.95					2.15	
2	2.26	1.85	1.00				2.06	
3	2.15	1.10 to 1.50	0.90				2.10	
4	2.35	1.10 to	1.50	0.90			2.12	
5	2.40	1.30	0.95				2.40	1.05
6	2.30	1.15 to	1.50	0.90			2.40	0.95
7	2.30	1.16		to	1.50	0.88	2.42	0.97

Table 3. C-13 NMR Chemical Shifts of Aliphatic Tertiary Amines in ppm Relative to TMS³ (Solvent CCl₄)

Compounds	C-1	C-2	C-3	C-4	C-5	C-6	C-1'	C-2'
1	53.2	12.8					44.8	
2	61.5	20.8	11.7				45.2	
3	59.2	29.8	20.4	14.0			45.2	
4	59.5	27.2	29.6	22.6	14.0		45.2	
5	55.0	20.5	11.9				46.9	12.0
6	52.8	26.9	29.7	22.6	14.2		46.8	12.0
7	53.0	27.3	27.4	31.9	22.7	14.0	46.9	12.1

Table 4. Empirical Effects of Aliphatic Tertiary Amines in ppm³

group	α	β	γ	δ
NMe ₂	46.1	4.8	-4.4	0.0
NEt ₂	39.5	4.5	-4.5	0.0

ACKNOWLEDGMENTS

The authors thank the Fundação de Amparo a Pesquisa do Estado de São Paulo (FAPESP) for financial support of this research and the Conselho Nacional de Desenvolvimento Científico e Tecnológico (CNPq) for a fellowship to R. R. and P. I. B. C, to whom correspondence should be addressed.

REFERENCES

1. P. I. B. Carneiro et al., *South. Braz. J. Chem.*, 1(1): 5-9, (1993).
2. E. Breitmaier and W. Voelter, "*Carbon-13 NMR Spectroscopy*", 3rd. edition, Weinheim, New York, USA, 1987.
3. P. I. B. Carneiro, *Tese de Mestrado*, UNICAMP, Campinas, S. P, Brasil, 1988.
4. B. S. Furniss et al. "*Vogel's Textbook of practical Organic Chemistry*". 4th edition, London, 1978.

SOUTHERN BRAZILIAN JOURNAL OF CHEMISTRY

ISSN 0104-5431

VOLUME THREE, NUMBER THREE

DECEMBER 1995

AUTHOR INDEX / ÍNDICE DE AUTORES

93

Basallote, Manuel G.	55
Carneiro, Paulo Irajara Borba	89
Cascaval, Dan	37
Da Rocha, Adriana Olmos	23
Das Neves, Paulo Cesar Pereira	23
De Souza, Elizabeth Fátima	63
Dumitrascu, Adina	37
Esteve-Juan, E.	9
Gavriliu, D.	79
Ionescu, Lavinel G.	1,63
Kist, Lourdes T.	55
Maior, O.	79
Maquieira, A.	9
Máñez, Maria A.	55
Oniscu, Corneliu	37
Perazzolo, Clóvis Antônio	1
Puchades, R.	9
Rittner, Roberto	89
Stoia, S.	79
Szpoganicz, Bruno	55
Trujillo, Maria J. F.	55

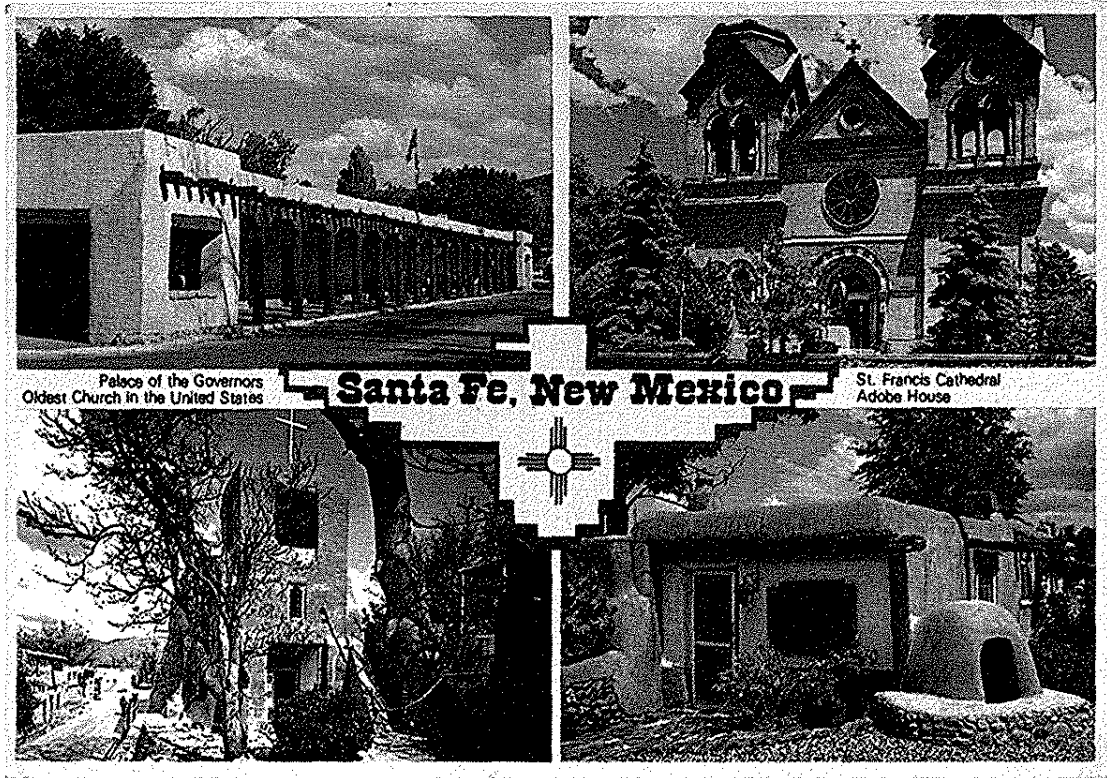

VIEWS OF SANTA FE, CAPITAL OF NEW MEXICO FOUNDED BY THE SPANISH
IN 1610.

VISTAS DE SANTA FÉ, CAPITAL DO NOVO MÉXICO FUNDADA PELOS ESPANHÓIS
EM 1610.

SOUTHERN BRAZILIAN JOURNAL OF CHEMISTRY

ISSN 0104-5431

The *SOUTHERN BRAZILIAN JOURNAL OF CHEMISTRY* is an international forum for the rapid publication of original scientific articles dealing with chemistry and related areas. At the present there are no page charges and the authors will receive twenty five free reprints of their papers.

SPECIAL COMBINATION OFFER FOR NEW SUBSCRIBERS!

SUBSCRIPTION INFORMATION

PRICE: Brazil and Latin America: US\$ 35.00 per issue.

Other Countries: US\$ 50.00 per issue, including
air mail delivery.

Persons or institutions outside Brazil should send
subscription fee payable to Dr. L. G. Ionescu, c/o SBJC
8532 Howard Circle, Huntington Beach, California, USA
92647

ORDER FORM

- Please enter my subscription for _____ issues of
Southern Brazilian Journal of Chemistry.
- Please send me _____ copies of the Southern Brazilian
Journal of Chemistry (Vol. 1,2,3 Nº 1,2,3 1993,1994,1995)
(Circle desired copies.)
- I enclose a check or money order in the amount of \$ _____
- Please send me a Pro Forma Invoice for the above
order.

SOUTHERN BRAZILIAN JOURNAL OF CHEMISTRY

Lavinel G. Ionescu, B.S., M.S., Ph.D., Editor
C.P. 15032, Agronomia
Porto Alegre, RS BRAZIL 91501-000
TEL. (051) 485-1820 FAX. (051) 339-1564
EMail: LGIPUCRS @ MUSIC.PUCRS.BR

INFORMATION FOR AUTHORS

The *Southern Brazilian Journal of Chemistry - SBJC* will publish review articles, original research papers and short communications dealing with chemistry and interdisciplinary areas such as materials science, biotechnology, bioengineering and other multidisciplinary fields.

Articles report the results of a complete study. They should include an *Abstract*, *Introduction* describing the known art in the field, *Experimental* or *Materials and Methods*, *Results and Discussion*, *Acknowledgments* (when appropriate) and *References*.

Short Communications should be limited to 1500 words, including the equivalent space for figures and/or tables and should include an *Abstract* and concise *Experimental*.

Manuscripts should be submitted in triplicate (original and two copies) and are received with the understanding that the original has not been submitted for publication elsewhere. It is implicit that all the persons listed as authors have given their approval for the submission of the paper and that permission has also been granted by the employer, when necessary.

Manuscripts must be written in American or British English, single spaced, on A 4 sheets (21 cm x 29.5 cm) and one side only and should be numbered beginning with the title page. Type must be 12 point or "pica". Dot matrix printer with less than 48 dots (240 dpi) is not acceptable. Margins of at least 3 cm should be left at the top and bottom and both sides of each page. The first page of the paper should contain only the title of the paper, the name(s) and address(es) of the author(s), an abstract of not more than 250 words and 4-8 keywords. We reserve the right to translate the abstract in Portuguese. Abstracts are required of all papers including reviews and short communications.

Figures and Tables with short explanatory titles, each on a separate sheet, should be adequate for direct reproduction and identified in pencil on the back of each page by Arabic numerals, corresponding to the order they appear in the manuscript.

References should be numbered in the sequence they appear in the text, cited by superior numbers and listed at the end of the paper in the reference section in the numerical order they appear in the text. The style for references is shown below:

1. L. G. Ionescu and D. S. Fung, *J. Chem. Soc. Faraday Trans. I*, 77, 2907-2912 (1981).
2. K. L. Mittal, Ed., *"Solution Chemistry Of Surfactants"*, Plenum Press, New York (1984), Vols. 1-3, pp. 1-2173.

IUPAC Rules should be used for the name of chemical compounds and preference should be given to SI units.

Additional information is available upon request.

Authors are invited to send manuscripts by registered air mail to the EDITOR - SBJC, C.P. 15032, Agronomia, Porto Alegre RS BRASIL 91501. Notice of receipt should be received within a maximum of one month.

SCIENCO SOUTHERN BRAZILIAN JOURNAL OF CHEMISTRY

ISSN 0104-5431

The *SOUTHERN BRAZILIAN JOURNAL OF CHEMISTRY - SCIENCO* publishes original research articles in chemistry and related interdisciplinary areas and is intended to fill a gap in terms of scientific information for Southern Brazil.

Occasionally the journal will include review papers and articles dealing with chemical education and philosophy and history of science. It will be published mainly in English, with abstracts in Portuguese and only occasional papers in other languages. At the present there are no page charges and the authors will receive twenty five reprints of their papers free of charge.

We have set high standards for the articles to be published by ensuring strong but fair refereeing by at least two reviewers. We hope that this journal will provide a forum for dissemination of high quality research in chemistry and related areas and are open to any questions and suggestions.

The Editor

SUBSCRIPTION INFORMATION

Brazil and Latin America:
US\$ 35.00 per issue.

Other Countries: US\$ 50.00 per issue,
including air mail delivery. Persons or
institutions outside Brazil should send
subscription fee payable to Dr. L. G. Ionescu,
c/o SBJC, 8532 Howard Circle, Huntington Beach,
California, USA 92647

MAILING ADDRESS

SOUTHERN BRAZILIAN JOURNAL OF CHEMISTRY - SBJC
Lavinel G. Ionescu, B.S., M.S., Ph.D., Editor
C.P. 15032, Agronomia
Porto Alegre, RS BRASIL 91501-000
Tel. (051) 485-1820 FAX (051) 339-1564

FINANCIAL SUPPORT

SARMISEGETUSA RESEARCH GROUP

SANTA FE, NEW MEXICO, U.S.A.



Endless Column, 1937, cast iron
CONSTANTIN BRĂNCUȘI